



Our commitment is **your safe future**

Electrical Installations from A to Z
Price List w.e.f. 15th October, 2024

SIEMENS



The safe choice –
now made smarter

SENTRON circuit protection devices with
communication and measuring function

[siemens.com/circuit-protection](https://www.siemens.com/circuit-protection)

SIEMENS



Sr. No.	Items	Pg. No.
1	Betagard Miniature Circuit Breakers	
	5SL6, 7.5kA with C characteristics	5
	5SL6, 7.5kA with B characteristics	6
	5SL4, 10kA with C characteristics	7
	5SL7, with C characteristics	8
2	Betagard Circuit Breakers	
	5SL7, with K characteristics	13
	5SL4, with Z characteristics	14
	5SY4, 10kA CBs with C characteristics	15
3	Betagard Isolators	
	5TL1 Isolators	16
4	Betagard DC Circuit Breakers	
	5SL5, 10kA DC with C characteristics	16
5	Betagard Residual Current Circuit Breakers	
	5SV RCCB - Type AC, Type A	20
6	SENTRON Residual Current Units	
	5SM2..RC, RC Units- Type AC, Type A	22
	Accessories selection - Remote control mechanism	23
7	Betagard Residual Current Breaker Operators	
	5SU1 RCBO, 10kA, Type AC with C and D characteristics	24
	5SU1 RCBO, 10kA, Type A with C and D characteristics	25
8	Betagard Accessories	26
9	SINOVA Opulenz	27
10	Arc Fault Detection Devices (AFDD)	28-29
11	SENTRON COM Devices NEW	30-31
	5SV6 AFDD COM	32
	7KN Powercenter 1000	32
12	SINOVA STR4 ACCL	33
13	Betagard Distribution Boards	
	8GB32 SPN, TPN & Phase Segregated DBs	35-37
	Industrial Plug & Socket DBs, Simbox WP DBs	38
	Accessories for Betagard DBs	39
14	SINOVA Low Voltage Switchgears	40
15	SENTRON Surge Protection Devices	
	Surge Protection Devices	42-44
16	SENTRON Modular Devices	
	Changeover switches, Insta contactors	45
	Twilight switch, Voltage relays, Indicators and Fuse monitors	47
	Time switches	48
17	SINOVA MCCBs - 3VJ, RAJA+ Starters	49-51
	ordering info	
18	Switch Disconnecter Fuses - 3KL and Fuses - 3NA/3NW ordering info	52
19	Available till stocks last	53-54
20	Discontinued products	55
21	Multi channel current measuring system	56-57
22	Technical Information	58-59
23	Customer Care	60

Betagard 5SL MCBs – Inspiring Safety



Unique SLR (Slide Latch-Release) feature for tool free removal from DIN rail allows individual MCB to be removed from bus bar mounted assembly without disturbing other devices





BIS approval for ISI marking as per latest IS/IEC 60898-1:2015 for assured quality and protection



Unique termination mechanism enables firm mounting of Bus bar together with wire; and provides front access to wires for safe installation

Betagard Miniature Circuit Breakers 5SL6, with C Characteristics

- Standards: IS/IEC 60898-1:2015
- Voltage: Un 240/415V, 50...60Hz[^]
- With ISI marking: CM/L No. 2255548

7500A	Rated Current I_n (A)	MW#	Reference No	Unit MRP* ₹	Std. Pkg.** (Nos.)
1P, 240/415V AC 	0.5	1	5SL61057RC	539.-	1/12
	1		5SL61017RC	539.-	1/12
	2		5SL61027RC	539.-	1/12
	3		5SL61037RC	539.-	1/12
	4		5SL61047RC	539.-	1/12
	6		5SL61067RC	334.-	1/12
	8		5SL61087RC	334.-	1/12
	10		5SL61107RC	334.-	1/12
	13		5SL61137RC	334.-	1/12
	16		5SL61167RC	334.-	1/12
	20		5SL61207RC	334.-	1/12
	25		5SL61257RC	334.-	1/12
	32		5SL61327RC	334.-	1/12
	40		5SL61407RC	735.-	1/12
	50		5SL61507RC	846.-	1/12
63	5SL61637RC	846.-	1/12		
2P, 415V AC 	0.5	2	5SL62057RC	1523.-	1/6
	1		5SL62017RC	1523.-	1/6
	2		5SL62027RC	1523.-	1/6
	3		5SL62037RC	1523.-	1/6
	4		5SL62047RC	1523.-	1/6
	6		5SL62067RC	1140.-	1/6
	8		5SL62087RC	1140.-	1/6
	10		5SL62107RC	1140.-	1/6
	13		5SL62137RC	1140.-	1/6
	16		5SL62167RC	1140.-	1/6
	20		5SL62207RC	1140.-	1/6
	25		5SL62257RC	1140.-	1/6
	32		5SL62327RC	1140.-	1/6
	40		5SL62407RC	1600.-	1/6
	50		5SL62507RC	1878.-	1/6
63	5SL62637RC	1878.-	1/6		
3P, 415V AC 	0.5	3	5SL63057RC	2138.-	1/4
	1		5SL63017RC	2138.-	1/4
	2		5SL63027RC	2138.-	1/4
	4		5SL63047RC	2138.-	1/4
	6		5SL63067RC	1712.-	1/4
	10		5SL63107RC	1712.-	1/4
	16		5SL63167RC	1712.-	1/4
	20		5SL63207RC	1712.-	1/4
	25		5SL63257RC	1712.-	1/4
	32		5SL63327RC	1712.-	1/4
	40		5SL63407RC	2396.-	1/4
	50		5SL63507RC	2676.-	1/4
	63		5SL63637RC	2676.-	1/4
4P, 415V AC 	0.5	4	5SL64057RC	2952.-	1/3
	1		5SL64017RC	2952.-	1/3
	2		5SL64027RC	2952.-	1/3
	4		5SL64047RC	2952.-	1/3
	6		5SL64067RC	2367.-	1/3
	10		5SL64107RC	2367.-	1/3
	16		5SL64167RC	2367.-	1/3
	20		5SL64207RC	2367.-	1/3
	25		5SL64257RC	2367.-	1/3
	32		5SL64327RC	2367.-	1/3
	40		5SL64407RC	3059.-	1/3
	50		5SL64507RC	3541.-	1/3
	63		5SL64637RC	3541.-	1/3

■ Stock items

Note:

* MRP - Maximum Retail Price





1MW (Module Width) = 18mm

** Purchase MOQ for our authorized dealers is in multiples of standard packing, contact Siemens Sales Office for further details

^ Suitable for DC networks in Telecom application; 60V DC for 1P & 110V DC for 2P (contact sales office for connection diagram)

Betagard Miniature Circuit Breakers 5SL6, with B Characteristics

- Standards: IS/IEC 60898-1:2015
- Voltage: Un 240/415V, 50...60Hz
- With ISI marking: CM/L No. 2255548

7500A	Rated Current I_n (A)	MW#	Reference No	Unit MRP* ₹	Std. Pkg.** (Nos.)
1P, 240/415V AC 	6	1	5SL61066RC	328.-	1/12
	10		5SL61106RC	328.-	1/12
	16		5SL61166RC	328.-	1/12
	20		5SL61206RC	328.-	1/12
	25		5SL61256RC	328.-	1/12
	32		5SL61326RC	328.-	1/12
	40		5SL61406RC	731.-	1/12
	50		5SL61506RC	822.-	1/12
	63		5SL61636RC	822.-	1/12
2P, 415V AC 	6	2	5SL62066RC	1127.-	1/6
	10		5SL62106RC	1127.-	1/6
	16		5SL62166RC	1127.-	1/6
	20		5SL62206RC	1127.-	1/6
	25		5SL62256RC	1127.-	1/6
	32		5SL62326RC	1127.-	1/6
	40		5SL62406RC	1585.-	1/6
	50		5SL62506RC	1863.-	1/6
	63		5SL62636RC	1863.-	1/6
3P, 415V AC 	6	3	5SL63066RC	1712.-	1/4
	10		5SL63106RC	1712.-	1/4
	16		5SL63166RC	1712.-	1/4
	20		5SL63206RC	1712.-	1/4
	25		5SL63256RC	1712.-	1/4
	32		5SL63326RC	1712.-	1/4
	40		5SL63406RC	2365.-	1/4
	50		5SL63506RC	2652.-	1/4
	63		5SL63636RC	2652.-	1/4
4P, 415V AC 	6	4	5SL64066RC	2354.-	1/3
	10		5SL64106RC	2354.-	1/3
	16		5SL64166RC	2354.-	1/3
	20		5SL64206RC	2354.-	1/3
	25		5SL64256RC	2354.-	1/3
	32		5SL64326RC	2354.-	1/3
	40		5SL64406RC	2938.-	1/3
	50		5SL64506RC	3531.-	1/3
	63		5SL64636RC	3531.-	1/3

■ Stock items

Note:





* MRP - Maximum Retail Price # 1MW (Module Width) = 18mm

** Purchase MOQ for our authorized dealers is in multiples of standard packing, contact Siemens Sales Office for further details



Betagard Miniature Circuit Breakers 5SL4, with C characteristics

- Standards: IS/IEC 60898-1:2015
- Voltage: Un 240/415V, 50...60Hz[^]
- Breaking capacity: 10kA as per IS/IEC 60898-1
- With ISI marking: CM/L No. 2255548

10000A	Rated Current I_n (A)	MW#	Reference No	Unit MRP* ₹	Std. Pkg.** (Nos.)
	1P, 240/415V AC	1	5SL41057RC	620.-	1/12
	2	5SL41027RC	620.-	1/12	
	3	5SL41037RC	620.-	1/12	
	4	5SL41047RC	620.-	1/12	
	6	5SL41067RC	401.-	1/12	
	8	5SL41087RC	401.-	1/12	
	10	5SL41107RC	401.-	1/12	
	13	5SL41137RC	401.-	1/12	
	16	5SL41167RC	401.-	1/12	
	20	5SL41207RC	401.-	1/12	
	25	5SL41257RC	401.-	1/12	
	32	5SL41327RC	401.-	1/12	
	40	5SL41407RC	874.-	1/12	
	50	5SL41507RC	900.-	1/12	
63	5SL41637RC	900.-	1/12		
	2P, 415V AC	2	5SL42057RC	1755.-	1/6
	2	5SL42027RC	1755.-	1/6	
	3	5SL42037RC	1755.-	1/6	
	4	5SL42047RC	1755.-	1/6	
	6	5SL42067RC	1258.-	1/6	
	8	5SL42087RC	1258.-	1/6	
	10	5SL42107RC	1258.-	1/6	
	13	5SL42137RC	1258.-	1/6	
	16	5SL42167RC	1258.-	1/6	
	20	5SL42207RC	1258.-	1/6	
	25	5SL42257RC	1258.-	1/6	
	32	5SL42327RC	1258.-	1/6	
	40	5SL42407RC	2029.-	1/6	
	50	5SL42507RC	2029.-	1/6	
63	5SL42637RC	2029.-	1/6		
	3P, 415V AC	3	5SL43057RC	2836.-	1/4
	2	5SL43027RC	2836.-	1/4	
	3	5SL43037RC	2836.-	1/4	
	4	5SL43047RC	2836.-	1/4	
	6	5SL43067RC	2113.-	1/4	
	8	5SL43087RC	2113.-	1/4	
	10	5SL43107RC	2113.-	1/4	
	13	5SL43137RC	2113.-	1/4	
	16	5SL43167RC	2113.-	1/4	
	20	5SL43207RC	2113.-	1/4	
	25	5SL43257RC	2113.-	1/4	
	32	5SL43327RC	2113.-	1/4	
	40	5SL43407RC	3197.-	1/4	
	50	5SL43507RC	3197.-	1/4	
63	5SL43637RC	3197.-	1/4		
	4P, 415V AC	4	5SL44057RC	3564.-	1/3
	2	5SL44027RC	3564.-	1/3	
	3	5SL44037RC	3564.-	1/3	
	4	5SL44047RC	3564.-	1/3	
	6	5SL44067RC	2925.-	1/3	
	8	5SL44087RC	2925.-	1/3	
	10	5SL44107RC	2925.-	1/3	
	13	5SL44137RC	2925.-	1/3	
	16	5SL44167RC	2925.-	1/3	
	20	5SL44207RC	2925.-	1/3	
	25	5SL44257RC	2925.-	1/3	
	32	5SL44327RC	2925.-	1/3	
	40	5SL44407RC	3990.-	1/3	
	50	5SL44507RC	3990.-	1/3	
63	5SL44637RC	3990.-	1/3		

■ Stock items

Note: * MRP - Maximum Retail Price # 1MW (Module Width) = 18mm





** Purchase MOQ for our authorized dealers is in multiples of standard packing, contact Siemens Sales Office for further details

^ Suitable for DC networks in Telecom application; 60V DC for 1P & 110V DC for 2P (contact sales office for connection diagram)

Betagard Miniature Circuit Breakers 5SL7, with C characteristics



- Standards: IS/IEC 60898-1:2015
- Voltage: Un 240/415V, 50...60Hz
- Breaking capacity: 15kA¹⁾ as per IS/IEC 60898-1
- With ISI marking: CM/L No. 2255548

	Rated Current I_n (A)	MW#	Reference No	Unit MRP* ₹	Std. Pkg.** (Nos.)
	0.5	1	5SL71057RC	695.-	1/12
	1		5SL71017RC	695.-	1/12
	2		5SL71027RC	685.-	1/12
	4		5SL71047RC	685.-	1/12
	6		5SL71067RC	590.-	1/12
	10		5SL71107RC	590.-	1/12
	16		5SL71167RC	590.-	1/12
	20		5SL71207RC	590.-	1/12
	25		5SL71257RC	590.-	1/12
	32		5SL71327RC	590.-	1/12
	40		5SL71407RC	925.-	1/12
	50		5SL71507RC	935.-	1/12
	63		5SL71637RC	935.-	1/12
	0.5	2	5SL72057RC	1975.-	1/6
	1		5SL72017RC	1975.-	1/6
	2		5SL72027RC	1940.-	1/6
	4		5SL72047RC	1940.-	1/6
	6		5SL72067RC	1410.-	1/6
	10		5SL72107RC	1410.-	1/6
	16		5SL72167RC	1410.-	1/6
	20		5SL72207RC	1410.-	1/6
	25		5SL72257RC	1410.-	1/6
	32		5SL72327RC	1410.-	1/6
	40		5SL72407RC	2125.-	1/6
	50		5SL72507RC	2125.-	1/6
	63		5SL72637RC	2125.-	1/6
	0.5	3	5SL73057RC	3030.-	1/4
	1		5SL73017RC	3030.-	1/4
	2		5SL73027RC	2975.-	1/4
	4		5SL73047RC	2975.-	1/4
	6		5SL73067RC	2245.-	1/4
	10		5SL73107RC	2245.-	1/4
	16		5SL73167RC	2245.-	1/4
	20		5SL73207RC	2245.-	1/4
	25		5SL73257RC	2245.-	1/4
	32		5SL73327RC	2245.-	1/4
	40		5SL73407RC	3345.-	1/4
	50		5SL73507RC	3345.-	1/4
	63		5SL73637RC	3345.-	1/4
	0.5	4	5SL74057RC	3820.-	1/3
	1		5SL74017RC	3820.-	1/3
	2		5SL74027RC	3750.-	1/3
	4		5SL74047RC	3750.-	1/3
	6		5SL74067RC	3005.-	1/3
	10		5SL74107RC	3005.-	1/3
	16		5SL74167RC	3005.-	1/3
	20		5SL74207RC	3005.-	1/3
	25		5SL74257RC	3005.-	1/3
	32		5SL74327RC	3005.-	1/3
	40		5SL74407RC	4210.-	1/3
	50		5SL74507RC	4210.-	1/3
	63		5SL74637RC	4210.-	1/3

Note:





* MRP - Maximum Retail Price # 1MW (Module Width) = 18mm

** Purchase MOQ for our authorized dealers is in multiples of standard packing, contact Siemens Sales Office for further details

¹⁾ Breaking capacity 63A - 10kA

Betagard Miniature Circuit Breakers 5SL7, with D characteristics

- Standards: IS/IEC 60898-1
- Voltage: Un 240/415V, 50...60Hz
- Breaking capacity: 15kA¹⁾ as per IS/IEC 60898-1
- With ISI marking: CM/L No. 2255548

	Rated Current I_n (A)	MW#	Reference No	Unit MRP* ₹	Std. Pkg.** (Nos.)
1P, 240/415V AC 	0.5	1	5SL71058RC	705.-	1/12
	1		5SL71018RC	705.-	1/12
	2		5SL71028RC	685.-	1/12
	4		5SL71048RC	685.-	1/12
	6		5SL71068RC	610.-	1/12
	10		5SL71108RC	610.-	1/12
	16		5SL71168RC	610.-	1/12
	20		5SL71208RC	610.-	1/12
	25		5SL71258RC	610.-	1/12
	32		5SL71328RC	610.-	1/12
	40		5SL71408RC	1190.-	1/12
	50		5SL71508RC	1190.-	1/12
	63		5SL71638RC	1190.-	1/12
2P, 415V AC 	0.5	2	5SL72058RC	2010.-	1/6
	1		5SL72018RC	2010.-	1/6
	2		5SL72028RC	1940.-	1/6
	4		5SL72048RC	1940.-	1/6
	6		5SL72068RC	1490.-	1/6
	10		5SL72108RC	1490.-	1/6
	16		5SL72168RC	1490.-	1/6
	20		5SL72208RC	1490.-	1/6
	25		5SL72258RC	1490.-	1/6
	32		5SL72328RC	1490.-	1/6
	40		5SL72408RC	2745.-	1/6
	50		5SL72508RC	2745.-	1/6
	63		5SL72638RC	2745.-	1/6
3P, 415V AC 	0.5	3	5SL73058RC	3090.-	1/4
	1		5SL73018RC	3090.-	1/4
	2		5SL73028RC	2975.-	1/4
	4		5SL73048RC	2975.-	1/4
	6		5SL73068RC	2360.-	1/4
	10		5SL73108RC	2360.-	1/4
	16		5SL73168RC	2360.-	1/4
	20		5SL73208RC	2360.-	1/4
	25		5SL73258RC	2360.-	1/4
	32		5SL73328RC	2360.-	1/4
	40		5SL73408RC	4280.-	1/4
	50		5SL73508RC	4280.-	1/4
	63		5SL73638RC	4280.-	1/4
4P, 415V AC 	0.5	4	5SL74058RC	3950.-	1/3
	1		5SL74018RC	3950.-	1/3
	2		5SL74028RC	3810.-	1/3
	4		5SL74048RC	3810.-	1/3
	6		5SL74068RC	3120.-	1/3
	10		5SL74108RC	3120.-	1/3
	16		5SL74168RC	3120.-	1/3
	20		5SL74208RC	3120.-	1/3
	25		5SL74258RC	3120.-	1/3
	32		5SL74328RC	3120.-	1/3
	40		5SL74408RC	5380.-	1/3
	50		5SL74508RC	5380.-	1/3
	63		5SL74638RC	5380.-	1/3

Note:

* MRP - Maximum Retail Price # 1MW (Module Width) = 18mm

** Purchase MOQ for our authorized dealers is in multiples of standard packing, contact Siemens Sales Office for further details

¹⁾ Breaking capacity 40A - 63A: 10kA

DISCOVER THE POWER OF SIMPLICITY

SINOVA 5TJ MCB

NEW

IEC

Safe
Complies with
IEC standards



Comprehensive
range
For various
applications



Reliable
Siemens trusted
quality



RoHS
compliance
Environmentally
friendly

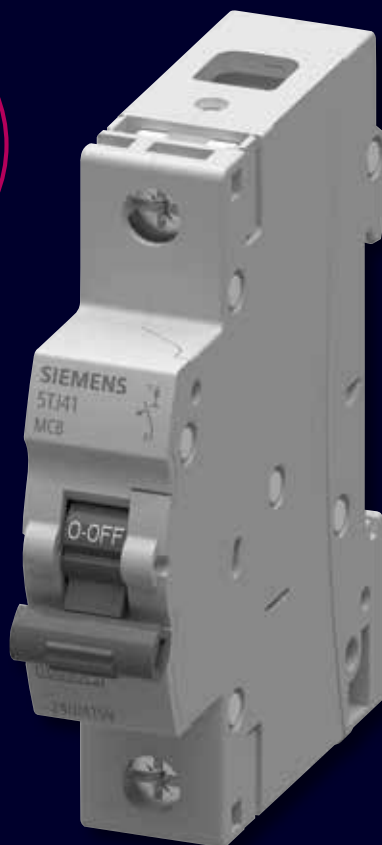

www.siemens.co.in

Learn more about our
low-voltage electrical
products or contact
us for a personalized
consultation and take
the first step towards
an efficient power
future.



SIEMENS

DISCOVER THE POWER OF **SIMPLICITY**

SINOVA low-voltage electrical products



Cost-effective
Best price performance ratio



Comprehensive range
For various applications



Reliable
Siemens trusted quality

IEC

Safe
Complies with IEC standards



www.siemens.co.in

Learn more about our low-voltage electrical products or contact us for a personalized consultation and take the first step towards an efficient power future.



SIEMENS

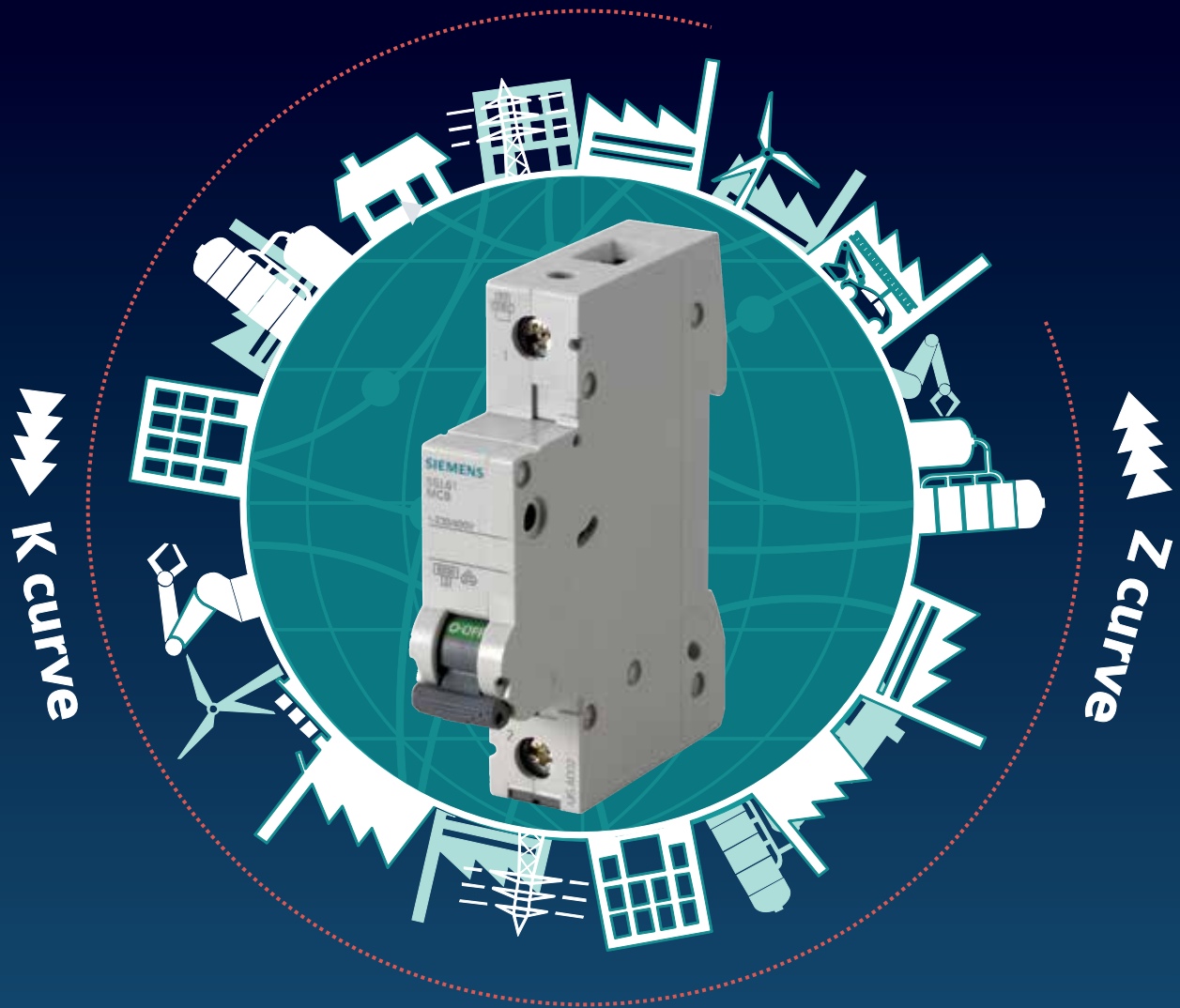

5SL Circuit Breaker - K & Z Curve

"K" Characteristic Trip Curve:

MCB trips instantaneously when the current flowing through it reaches between 10 to 14 times the rated current.

Suitable for inductive and motor loads with high inrush currents; etc

"Z" Characteristic Trip Curve:

MCB trips when the current flowing through it reaches between 2 to 3 times the rated current, highly sensitive to short circuit current

Suitable for the protection of highly sensitive devices such as semiconductor devices,

- In compliance with standards IEC 60947-2
- Range available from 2A – 63A
- Comprehensive features & accessories in line with 5SL MCB
- For protection in Industrial, Infrastructure, Process Automation, Commercial applications

www.siemens.co.in



SIEMENS

Betagard Circuit Breakers 5SL7, with K characteristics



L - 7500266715

- Standards: IS/IEC 60947-2:2016
- Voltage: Un 240/415V, 50...60Hz
- Breaking capacity (Icu): 15kA¹⁾ as per IS/IEC 60947-2

	Rated Current I _n (A)	MW#	Reference No	Unit MRP* ₹	Std. Pkg.** (Nos.)
1P, 240/415V AC 	2	1	5SL71023RC	610.-	1/12
	4		5SL71043RC	610.-	1/12
	6		5SL71063RC	545.-	1/12
	10		5SL71103RC	540.-	1/12
	16		5SL71163RC	545.-	1/12
	20		5SL71203RC	540.-	1/12
	25		5SL71253RC	545.-	1/12
	32		5SL71323RC	545.-	1/12
	40		5SL71403RC	960.-	1/12
	63		5SL71633RC	1125.-	1/12
2P, 415V AC 	2	2	5SL72023RC	1855.-	1/6
	4		5SL72043RC	1855.-	1/6
	6		5SL72063RC	1720.-	1/6
	10		5SL72103RC	1685.-	1/6
	16		5SL72163RC	1720.-	1/6
	20		5SL72203RC	1685.-	1/6
	25		5SL72253RC	1720.-	1/6
	32		5SL72323RC	1720.-	1/6
	40		5SL72403RC	2080.-	1/6
	63		5SL72633RC	2390.-	1/6
3P, 415V AC 	2	3	5SL73023RC	2885.-	1/4
	4		5SL73043RC	2885.-	1/4
	6		5SL73063RC	2640.-	1/4
	10		5SL73103RC	2585.-	1/4
	16		5SL73163RC	2640.-	1/4
	20		5SL73203RC	2585.-	1/4
	25		5SL73253RC	2640.-	1/4
	32		5SL73323RC	2640.-	1/4
	40		5SL73403RC	2940.-	1/4
	63		5SL73633RC	3300.-	1/4
4P, 415V AC 	2	4	5SL74023RC	3680.-	1/3
	4		5SL74043RC	3680.-	1/3
	6		5SL74063RC	3475.-	1/3
	10		5SL74103RC	3405.-	1/3
	16		5SL74163RC	3475.-	1/3
	20		5SL74203RC	3405.-	1/3
	25		5SL74253RC	3475.-	1/3
	32		5SL74323RC	3475.-	1/3
	40		5SL74403RC	3795.-	1/3
	63		5SL74633RC	4270.-	1/3

Note:

* MRP - Maximum Retail Price # 1MW (Module Width) = 18mm

** Purchase MOQ for our authorized dealers is in multiples of standard packing, contact Siemens Sales Office for further details





¹⁾ Breaking capacity 40A - 63A: 10kA

Betagard Circuit Breakers 5SL4, with Z characteristics



L - 7500266715

- Standards: IS/IEC 60947-2:2016
- Voltage: Un 240/415V, 50...60Hz
- Breaking capacity (Icu): 15kA¹⁾ as per IS/IEC 60947-2

	Rated Current I_n (A)	MW#	Reference No	Unit MRP* ₹	Std. Pkg.** (Nos.)
1P, 240/415V AC 	2	1	5SL41020RC	835.-	1/12
	4		5SL41040RC	835.-	1/12
	6		5SL41060RC	656.-	1/12
	10		5SL41100RC	656.-	1/12
	16		5SL41160RC	656.-	1/12
	20		5SL41200RC	656.-	1/12
	25		5SL41250RC	656.-	1/12
	32		5SL41320RC	656.-	1/12
	40		5SL41400RC	865.-	1/12
	63		5SL41630RC	865.-	1/12
2P, 415V AC 	2	2	5SL42020RC	1595.-	1/6
	4		5SL42040RC	1595.-	1/6
	6		5SL42060RC	1505.-	1/6
	10		5SL42100RC	1505.-	1/6
	16		5SL42160RC	1505.-	1/6
	20		5SL42200RC	1505.-	1/6
	25		5SL42250RC	1505.-	1/6
	32		5SL42320RC	1505.-	1/6
	40		5SL42400RC	1745.-	1/6
	63		5SL42630RC	1745.-	1/6
3P, 415V AC 	2	3	5SL43020RC	2528.-	1/4
	4		5SL43040RC	2528.-	1/4
	6		5SL43060RC	2106.-	1/4
	10		5SL43100RC	2106.-	1/4
	16		5SL43160RC	2106.-	1/4
	20		5SL43200RC	2106.-	1/4
	25		5SL43250RC	2106.-	1/4
	32		5SL43320RC	2106.-	1/4
	40		5SL43400RC	2648.-	1/4
	63		5SL43630RC	2648.-	1/4
4P, 415V AC 	2	4	5SL44020RC	2738.-	1/3
	4		5SL44040RC	2738.-	1/3
	6		5SL44060RC	2378.-	1/3
	10		5SL44100RC	2378.-	1/3
	16		5SL44160RC	2378.-	1/3
	20		5SL44200RC	2378.-	1/3
	25		5SL44250RC	2378.-	1/3
	32		5SL44320RC	2378.-	1/3
	40		5SL44400RC	2985.-	1/3
	63		5SL44630RC	2985.-	1/3

Note:

* MRP - Maximum Retail Price # 1MW (Module Width) = 18mm

** Purchase MOQ for our authorized dealers is in multiples of standard packing, contact Siemens Sales Office for further details

Betagard Circuit Breakers 5SY4, with C characteristics

- Standards: IS/IEC 60947-2:2016
- Voltage: Un 240/415V, 50...60Hz
- Breaking capacity (Icu): 15kA¹⁾ as per IS/IEC 60947-2

C characteristic

10000A		Rated Current I _n (A)	MW#	Reference No	Unit MRP* ₹	Std. Pkg.** (Nos.)
	1Pole	80A	1	5SY41807CC	4875.-	1/1
	2Pole		2	5SY42807CC	9585.-	1/1
	3Pole		3	5SY43807CC	14960.-	1/1
	4Pole		4	5SY44807CC	21430.-	1/1



Betagard Miniature Circuit Breakers 5SP4, with C/D characteristics

IS/IEC 60898 - 1





- Standards: IS/IEC 60898-1:2002
- Voltage: Un 240/415V
- Breaking capacity: 10kA as per IS/IEC 60898-1:2002
- With ISI marking: CM/L No. 2255548

C characteristic

10000A		Rated Current I _n (A)	MW#	Reference No	Unit MRP* ₹	Std. Pkg.** (Nos.)
	1-pole	80	1.5	5SP41807RC	4285.-	1/10
		100		5SP41917RC	4520.-	1/10
		125		5SP41927RC	5130.-	1/10
	2-pole	80	3	5SP42807RC	8415.-	1/5
		100		5SP42917RC	8870.-	1/5
		125		5SP42927RC	10040.-	1/5
	3-pole	80	4.5	5SP43807RC	13140.-	1/1
		100		5SP43917RC	13485.-	1/1
		125		5SP43927RC	15455.-	1/1
	4-pole	80	6	5SP44807RC	18845.-	1/1
		100		5SP44917RC	19390.-	1/1
		125		5SP44927RC	22075.-	1/1

D characteristic

	1-pole	80	1.5	5SP41808RC	4720.-	1/10
		100		5SP41918RC	4950.-	1/10
	2-pole	80	3	5SP42808RC	9475.-	1/5
		100		5SP42918RC	10045.-	1/5
	3-pole	80	4.5	5SP43808RC	14595.-	1/1
		100		5SP43918RC	14745.-	1/1
	4-pole	80	6	5SP44808RC	20530.-	1/1
		100		5SP44918RC	21055.-	1/1

Note:



* MRP - Maximum Retail Price

1MW (Module Width) = 18mm

** Purchase MOQ for our authorized dealers is in multiples of standard packing, contact Siemens Sales Office for further details

Betagard Circuit Breakers 5SL5, DC with C Characteristics

- Standards: IS/IEC 60947-2:2016
- Voltage: 220V DC/1P & 440V DC/2P^
- Breaking capacity: 10kA as per IS/IEC 60947-2

10000A	Rated Current I_n (A)	MW#	Reference No	Unit MRP* ₹	Std. Pkg.** (Nos.)
	1P, 220V DC	1	5SL51057RC	1020.-	1/12
		1	5SL51017RC	1020.-	1/12
		2	5SL51027RC	1095.-	1/12
		3	5SL51037RC	1150.-	1/12
		4	5SL51047RC	1095.-	1/12
		6	5SL51067RC	930.-	1/12
		8	5SL51087RC	985.-	1/12
		10	5SL51107RC	930.-	1/12
		16	5SL51167RC	930.-	1/12
		20	5SL51207RC	930.-	1/12
		25	5SL51257RC	930.-	1/12
		32	5SL51327RC	930.-	1/12
		40	5SL51407RC	1395.-	1/12
		50	5SL51507RC	1395.-	1/12
		63	5SL51637RC	1395.-	1/12
	2P, 440V DC	2	5SL52057RC	2215.-	1/6
		1	5SL52017RC	2215.-	1/6
		2	5SL52027RC	2215.-	1/6
		3	5SL52037RC	2320.-	1/6
		4	5SL52047RC	2215.-	1/6
		6	5SL52067RC	1940.-	1/6
		8	5SL52087RC	2035.-	1/6
		10	5SL52107RC	1940.-	1/6
		16	5SL52167RC	1940.-	1/6
		20	5SL52207RC	1940.-	1/6
		25	5SL52257RC	1940.-	1/6
		32	5SL52327RC	1940.-	1/6
		40	5SL52407RC	2870.-	1/6
		50	5SL52507RC	2870.-	1/6
		63	5SL52637RC	2870.-	1/6



■ Stock items

^ For connection diagram, contact Siemens Sales Office for further details.

• Also available DC Circuit Breakers for Solar applications - contact Siemens sales office for further details.

Betagard Isolators 5TL1

- Standard: IS/IEC 60947-3
- Voltage: 440V AC

	Rated Current I_n (A)	MW#	Reference No	Unit MRP* ₹	Std. Pkg.** (Nos.)
	2-pole	2	5TL12400	955.-	1/1
		63	5TL12630	1255.-	1/1
		80	5TL12800	1645.-	1/1
		100	5TL12910	2090.-	1/1
		125	5TL12920	2180.-	1/1
	3-pole	3	5TL13400	1775.-	1/1
		63	5TL13630	1990.-	1/1
		80	5TL13800	2405.-	1/1
		100	5TL13910	2530.-	1/1
		125	5TL13920	2730.-	1/1
	4-pole	4	5TL14400	2080.-	1/1
		63	5TL14630	2370.-	1/1
		80	5TL14800	2850.-	1/1
		100	5TL14910	3425.-	1/1
		125	5TL14920	3710.-	1/1

Note:

* MRP - Maximum Retail Price # 1MW (Module Width) = 18mm

** Purchase MOQ for our authorized dealers is in multiples of standard packing, contact Siemens Sales Office for further details

Betagard Circuit Breakers 5SL5, 4-pole DC with C Characteristics

- Standards: IS/IEC 60947-2:2016
- Voltage: 880V DC/4P[^]
- Breaking capacity: 10kA as per IS/IEC 60947-2

10000A	Rated Current I_n (A)	MW#	Reference No	Unit MRP* ₹	Std. Pkg.** (Nos.)
	4P, 880V DC ¹⁾	4	5SL54067RC	3920.-	1/3
	6		5SL54107RC	3920.-	1/3
	10		5SL54167RC	3920.-	1/3
	16		5SL54257RC	4170.-	1/3
	25		5SL54327RC	4170.-	1/3
	32		5SL54407RC	4905.-	1/3
	40		5SL54637RC	5145.-	1/3
63					

1) Maximum operational voltage 1000V DC

[^] For connection diagram, contact Siemens Sales Office for further details.

Note:

* MRP - Maximum Retail Price # 1MW (Module Width) = 18mm

** Purchase MOQ for our authorized dealers is in multiples of standard packing, contact Siemens Sales Office for further details



SIEMENS



Celebrate Life, while we Care.

Betagard 5SV

Residual Current Circuit Breakers



In the event of a fault,
residual current protective
devices reliably disconnect
power to protect humans

Fault protection

"Protection against indirect contact"

Protects people in the event of contact with electrically conductive parts, if a risk exists as a result of a fault due to the magnitude or duration of the touch voltage



Additional protection

"Protection in case of direct contact" with $I_{\Delta n} = 30\text{mA}$

Protects individuals if they come in direct contact with an active live part under normal operating condition



Fire protection

"Protection from insulation faults" with $I_{\Delta n} = 300\text{mA}$

For the prevention of fires which can be caused by insulation faults in locations exposed to fire hazards



Surge current withstand capability

"Protection surge currents" with $8/20\mu\text{s} > 1000\text{Amp}$

For Type "A"  have a surge current capability to avoid nuisance tripping





Betagard Residual Current Circuit Breakers 5SV





- Standards: IS 12640 (Part 1):2016/ IEC 61008-1:2012
- Voltage: 240/415V AC, 50Hz
- With ISI marking: CM/L No. 7676092

Type AC, applicable in networks for AC residual currents

	Rated residual current $I_{\Delta n}$ (mA)	Rated Current I_n (A)	MW#	Reference No	Unit MRP* ₹	Std. Pkg.** (Nos.)
	30	25	2	■ 5SV43120RC	4525.-	1
	100	25		5SV44120RC	4725.-	1
	300	25		5SV46120RC	4885.-	1
	30	40		■ 5SV43140RC	5305.-	1
	100	40		5SV44140RC	5540.-	1
	300	40		5SV46140RC	5750.-	1
	30	63		■ 5SV43160RC	7095.-	1
	100	63		5SV44160RC	7145.-	1
	300	63		5SV46160RC	7595.-	1
	30	80		5SV43170RC	10965.-	1
	100	80		5SV44170RC	11405.-	1
	300	80		5SV46170RC	11405.-	1
	30	25	4	■ 5SV43420RC	6065.-	1
	100	25		5SV44420RC	6285.-	1
	300	25		5SV46420RC	6515.-	1
	30	40		■ 5SV43440RC	6130.-	1
	100	40		5SV44440RC	6370.-	1
	300	40		5SV46440RC	6615.-	1
	30	63		■ 5SV43460RC	7145.-	1
	100	63		5SV44460RC	7430.-	1
	300	63		5SV46460RC	7695.-	1
	30	80		5SV43470RC	10965.-	1
	100	80		5SV44470RC	11405.-	1
	300	80		5SV46470RC	11405.-	1

Type A, applicable in networks with AC and/or pulsating DC residual currents

	30	25	2	5SV33126RC	8275.-	1
	100	25		5SV34126RC	9755.-	1
	300	25		5SV36126RC	9755.-	1
	30	40		5SV33146RC	9385.-	1
	100	40		5SV34146RC	9775.-	1
	300	40		5SV36146RC	9775.-	1
	30	63		5SV33166RC	13650.-	1
	100	63		5SV34166RC	14035.-	1
	300	63		5SV36166RC	13365.-	1
	30	80		5SV33176RC	14680.-	1
	100	80		5SV34176RC	15790.-	1
	300	80		5SV36176RC	15035.-	1
	30	25	4	5SV33426RC	9810.-	1
	100	25		5SV34426RC	12110.-	1
	300	25		5SV36426RC	12110.-	1
	30	40		5SV33446RC	10940.-	1
	100	40		5SV34446RC	12225.-	1
	300	40		5SV36446RC	12110.-	1
	30	63		5SV33466RC	12380.-	1
	100	63		5SV34466RC	12295.-	1
	300	63		5SV36466RC	12295.-	1
	30	80		5SV33476RC	14880.-	1
	100	80		5SV34476RC	15790.-	1
	300	80		5SV36476RC	15035.-	1

■ Stock items

Note:

* MRP - Maximum Retail Price # 1MW (Module Width) = 18mm

** Purchase MOQ for our authorized dealers is in multiples of standard packing, contact Siemens Sales Office for further details

SENTRON 5SM2

Residual Current Units



RC Units suitable with 5SL7..RC MCBs for complete protection from Residual current, Over load and Short circuit faults



Easy and Fast Installation



Reduced Inventory with range up to 63A in two variants only

Wide portfolio catering to various applications



Confirming to
- IEC/EN 61009-1
- IEC/EN 61009-2-1
- IEC/EN 61543





RoHS compliant





SENTRON Residual Current Units 5SM2

- Standards: In accordance with IEC/EN 61009-1 (VDE 0664-20), IEC/EN 61009-2-1 (VDE 0664-21), IEC/EN 61543 (VDE 0664-30)
- Voltage: 240/415V AC, 50Hz

Type AC, applicable in networks for AC residual currents

	Number of poles	Mounting width MW#	Rated residual current I _{Δn} [mA]	RC Unit-Current Rating [A]	5SL7..RC MCBs- Rated current [A]	Reference No	Unit LP* ₹	Std. Pkg.** (Nos.)
	2	2	10	40	2- 40	5SM21210RC	4275.-	1
			30	40	2- 40	5SM23220RC	3785.-	1
				63	2- 63	5SM23250RC	6220.-	1
			100	40	2- 40	5SM24220RC	4670.-	1
				63	2- 63	5SM24250RC	6775.-	1
	3	3	30	40	2- 40	5SM23320RC	4260.-	1
				63	2- 63	5SM23350RC	6420.-	1
			100	40	2- 40	5SM24320RC	5080.-	1
				63	2- 63	5SM24350RC	6995.-	1
			300	40	2- 40	5SM26320RC	5305.-	1
	63	2- 63	5SM26350RC	7155.-	1			
	4	3	30	40	2- 40	5SM23420RC	4630.-	1
				63	2- 63	5SM23450RC	6005.-	1
			100	40	2- 40	5SM24420RC	5410.-	1
				63	2- 63	5SM24450RC	6265.-	1
			300	40	2- 40	5SM26420RC	5630.-	1
				63	2- 63	5SM26450RC	6425.-	1

Type A, applicable in networks with AC and/or pulsating DC residual currents

	Number of poles	Mounting width MW#	Rated residual current I _{Δn} [mA]	RC Unit-Current Rating [A]	5SL7..RC MCBs- Rated current [A]	Reference No	Unit LP* ₹	Std. Pkg.** (Nos.)
	2	2	10	40	2- 40	5SM21216RC	4350.-	1
			30	40	2- 40	5SM23226RC	3795.-	1
				63	2- 63	5SM23256RC	6460.-	1
			100	40	2- 40	5SM24226RC	5080.-	1
				63	2- 63	5SM24256RC	5735.-	1
	3	3	30	40	2- 40	5SM23326RC	4305.-	1
				63	2- 63	5SM23356RC	6590.-	1
			100	40	2- 40	5SM24326RC	5140.-	1
				63	2- 63	5SM24356RC	7170.-	1
			300	40	2- 40	5SM26326RC	5355.-	1
	63	2- 63	5SM26356RC	7335.-	1			
	4	3	30	40	2- 40	5SM23426RC	5170.-	1
				63	2- 63	5SM23456RC	6160.-	1
			100	40	2- 40	5SM24426RC	5615.-	1
				63	2- 63	5SM24456RC	6425.-	1
			300	40	2- 40	5SM26426RC	5850.-	1
	63	2- 63	5SM26456RC	6595.-	1			

■ Stock items

Note: * LP - List Price

1MW (Module Width) = 18mm

** Purchase MOQ for our authorized dealers is in multiples of standard packing, contact Siemens Sales Office for further details

**Note: To be used along with 5SL7..RC MCBs. MCBs to be ordered separately.
For MCB prices, refer Page no. 8 & 9 from this pricelist.**

Accessories for Remote control mechanism units for 5SM2 RC Units

Remote control mechanism unit:

Adapter- Mount-on device for combination of RC Units 5SM2..RC and MCBs 5SL7..RC.

Item Description	Mounting width MW#	Reference No	Std. Pkg. ** (Nos.)
RC Mech. Power- 5ST3055 & RC Mech. ARD*- 5ST3057 For 2P- 12 V -30 V AC 12 V -48V DC	2	5ST3820-3 + 5ST3820-6	1
RC Mech. Power- 5ST3055 & RC Mech. ARD*- 5ST3057 For 3P & 4P- 12 V -30 V AC 12 V -48V DC	2	5ST3820-3 + 5ST3820-7	1
RC Mech. Power- 5ST3056 & RC Mech. ARD*- 5ST3058 For 2P- 230 V AC	2	5ST3820-3 + 5ST3820-6	1
RC Mech. Power- 5ST3056 & RC Mech. ARD*- 5ST3058 For 3P & 4P- 230 V AC	2	5ST3820-3 + 5ST3820-7	1
RC Mech. Power- 5ST3070 For 2P- 12 V -30 V AC 12 V -48V DC	2	5ST3820-3 + 5ST3820-6	1
RC Mech. Power- 5ST3070 For 3P & 4P- 12 V -30 V AC 12 V -48V DC	2	5ST3820-3 + 5ST3820-7	1

*- Auto Reclose Device

1MW (Module Width) = 18mm

** Purchase MOQ for our authorized dealers is in multiples of standard packing, contact Siemens Sales Office for further details

Note: All accessories can be mounted on the right-hand side of the RC Unit+MCB assembled device.

Note: For pricing details of above mentioned MLFBs and for other 5SM2 accessories, Pl refer Page No. 26 of this Pricelist.

Betagard Residual Current Breaker Operators 5SU1, 10kA





- Standards: IS 12640, Part 2:2016/ IEC 61009-1:2012
- Voltage: 240/415V AC, 50Hz
- With ISI marking: CM/L No. 7676193



Type AC, with C Characteristics (in 2 module size)⁵

	Rated residual current I _{Δn} (mA)	Rated Current I _n (A)	MW#	Reference No	Unit MRP* ₹	Std. Pkg.** (Nos.)
	30	6	2	5SU13541RC06	7910.-	1
	30	10		5SU13541RC10	7910.-	1
	30	16		5SU13541RC16	7910.-	1
	30	20		5SU13541RC20	7910.-	1
	30	25		5SU13541RC25	7910.-	1
	30	32		5SU13541RC32	8305.-	1
	30	40		5SU13541RC40	9815.-	1
	300	6		5SU16541RC06	8050.-	1
	300	10		5SU16541RC10	8050.-	1
	300	16		5SU16541RC16	8050.-	1
	300	20		5SU16541RC20	8050.-	1
	300	25		5SU16541RC25	8050.-	1
	300	32		5SU16541RC32	8470.-	1
	300	40		5SU16541RC40	10010.-	1

Type AC with C characteristic

	240V AC; 50Hz; 2 pole	30	32	4	5SU13241RC32	8735.-	1
		40	5SU13241RC40		10175.-	1	
		63	5SU13241RC63		11825.-	1	
	100	32	5SU14241RC32		9640.-	1	
		40	5SU14241RC40		10835.-	1	
		63	5SU14241RC63		12630.-	1	
	300	32	5SU16241RC32		9735.-	1	
		40	5SU16241RC40		10940.-	1	
		63	5SU16241RC63		12630.-	1	
	415V AC; 50Hz; 4 pole	30	32	7	5SU13441RC32	11665.-	1
		40	5SU13441RC40		11875.-	1	
		63	5SU13441RC63		14095.-	1	
	100	32	5SU14441RC32		11810.-	1	
		40	5SU14441RC40		12035.-	1	
		63	5SU14441RC63		13835.-	1	
	300	32	5SU16441RC32		11905.-	1	
		40	5SU16441RC40		12135.-	1	
		63	5SU16441RC63		13965.-	1	

Type AC with D characteristic

	240V AC; 50Hz; 2 pole	30	32	4	5SU13242RC32	11265.-	1
		40	5SU13242RC40		12340.-	1	
		63	5SU13242RC63		14875.-	1	
	100	32	5SU14242RC32		13630.-	1	
		40	5SU14242RC40		14920.-	1	
		63	5SU14242RC63		17035.-	1	
	300	32	5SU16242RC32		13320.-	1	
		40	5SU16242RC40		14920.-	1	
		63	5SU16242RC63		17060.-	1	
	415V AC; 50Hz; 4 pole	30	32	7	5SU13442RC32	15425.-	1
		40	5SU13442RC40		15655.-	1	
		63	5SU13442RC63		18570.-	1	
	100	32	5SU14442RC32		16695.-	1	
		40	5SU14442RC40		17440.-	1	
		63	5SU14442RC63		19340.-	1	
	300	32	5SU16442RC32		16495.-	1	
		40	5SU16442RC40		17610.-	1	
		63	5SU16442RC63		18935.-	1	

Note: * MRP - Maximum Retail Price # 1MW (Module Width) = 18mm ¹⁾ 1P+N variant

** Purchase MOQ for our authorized dealers is in multiples of standard packing, contact Siemens Sales Office for further details

\$ For connecting accessories with 2P 2M RCBO add handle connector 5ST38051



Betagard Residual Current Breaker Operators 5SU1, 10kA

- Standards: IS 12640, Part 2:2016/ IEC 61009-1:2012
- Voltage: 240/415V AC, 50Hz
- With ISI marking: CM/L No. 7676193



Type A, with C Characteristics (in 2 module size)[§]

	Rated residual current $I_{\Delta n}$ (mA)	Rated Current I_n (A)	MW#	Reference No	Unit MRP* ₹	Std. Pkg.** (Nos.)
	240V AC; 50Hz; 2 pole ¹⁾	30	2	5SU13547RC06	14450.-	1
		30		5SU13547RC10	14450.-	1
		30		5SU13547RC16	14450.-	1
		30		5SU13547RC20	14450.-	1
		30		5SU13547RC25	14450.-	1
		30		5SU13547RC32	15105.-	1
		30		5SU13547RC40	18270.-	1
		300		5SU16547RC06	14875.-	1
		300		5SU16547RC10	14875.-	1
		300		5SU16547RC16	14875.-	1
		300		5SU16547RC20	14875.-	1
		300		5SU16547RC25	14875.-	1
		300		5SU16547RC32	15470.-	1
		300		5SU16547RC40	18655.-	1

Type A with C characteristic

	240V AC; 50Hz; 2 pole	30	4	5SU13247RC32	15825.-	1
				5SU13247RC40	17410.-	1
				5SU13247RC63	19695.-	1
		100		5SU14247RC32	16885.-	1
				5SU14247RC40	18760.-	1
				5SU14247RC63	21315.-	1
		300		5SU16247RC32	16885.-	1
				5SU16247RC40	18760.-	1
				5SU16247RC63	21315.-	1
	415V AC; 50Hz; 4 pole	30	7	5SU13447RC32	19370.-	1
				5SU13447RC40	20170.-	1
				5SU13447RC63	23075.-	1
		100		5SU14447RC32	20790.-	1
				5SU14447RC40	21180.-	1
				5SU14447RC63	23675.-	1
		300		5SU16447RC32	20790.-	1
				5SU16447RC40	21545.-	1
				5SU16447RC63	24045.-	1

Type A with D characteristic

	240V AC; 50Hz; 2 pole	30	4	5SU13248RC32	18465.-	1
				5SU13248RC40	20840.-	1
				5SU13248RC63	23710.-	1
		100		5SU14248RC32	19865.-	1
				5SU14248RC40	22095.-	1
				5SU14248RC63	25175.-	1
		300		5SU16248RC32	19865.-	1
				5SU16248RC40	22095.-	1
				5SU16248RC63	25175.-	1
	415V AC; 50Hz; 4 pole	30	7	5SU13448RC32	22860.-	1
				5SU13448RC40	23145.-	1
				5SU13448RC63	27300.-	1
		100		5SU14448RC32	24080.-	1
				5SU14448RC40	25730.-	1
				5SU14448RC63	28015.-	1
		300		5SU16448RC32	24080.-	1
				5SU16448RC40	25730.-	1
				5SU16448RC63	28020.-	1

Note: * MRP - Maximum Retail Price

1MW (Module Width) = 18mm





¹⁾ 1P+N variant

** Purchase MOQ for our authorized dealers is in multiples of standard packing, contact Siemens Sales Office for further details

§ For connecting accessories with 2P 2M RCBO add handle connector 5ST38051

Betagard Accessories

Accessories for 5SL / 5SY / 5SP MCBs, 5TL Isolators, 5SV RCCBs, 5SM2 RC Units and 5SU1 RCBOs

	Item Description	Reference No	Unit MRP* ₹	Std. Pkg.** (Nos.)	
	Aux contact block (For 5SL/5SY/5SP4/5TL/5SV/5SU1/5SM2)				
	1NO+1NC	5ST3010	1685.-	12	
	2NO	5ST3011	1720.-	1	
	2NC	5ST3012	1720.-	1	
	1CO	5ST3016	2725.-	1	
	Fault signal contact (For 5SL/5SY/5SP4/5SV/5SU1/5SM2)				
	1NO+1NC	5ST3020	2475.-	1	
	2NO	5ST3021	2520.-	1	
	2NC	5ST3022	2520.-	1	
	Shunt release (For 5SL5/5SL7/5SY/5SP4/5SV/5SU1/5SM2)				
110...415V AC	5ST3030	6950.-	1/5		
24...48V DC	5ST3031	6950.-	1/5		
Auxiliary and fault signal changeover contact (5SL/5SY/5SP4/5TL/5SV/5SU1/5SM2)					
Auxiliary switch - 1CO Fault contact - 1CO	5ST3062	8020.-	1		
	Undervoltage release (For 5SL5/5SL7/5SY/5SP4/5SV/5SU1/5SM2)				
	With integrated aux. switch				
	230V AC	5ST3040	9330.-	1/5	
	110V DC	5ST3041	9330.-	1/5	
	24V DC	5ST3042	9330.-	1/5	
	Without integrated aux. switch				
	230V AC	5ST3043	9330.-	1/5	
	110V DC	5ST3044	9330.-	1/5	
	24V DC	5ST3045	9330.-	1/5	
		Remote control mechanism unit			
Basic version for 5SL, 5SY, 5TL1 and 5SU1 (1P+N only) (12-30)V AC & (12-48)V DC, 1.5MW 230V AC, 2MW		5ST3053 5ST3054	41625.- 41625.-	1 1	
Power version for 5SL, 5SY, 5TL1, 5SU1 & 5SM2 (12-30)V AC & (12-48)V DC, 2MW 230V AC, 2MW		5ST3055 5ST3056	70440.- 70440.-	1 1	
Power version for 5SM2 (12-30)V AC & (12-48)V DC, 2MW		5ST3070	82195.-	1	
Auto Reclose Device Version for 5SM2 (12-30)V AC & (12-48)V DC, 2MW 230V AC, 2MW		5ST3057 5ST3058	82195.- 79075.-	1 1	
Adapter for Remote control mechanism (To be ordered along with 5ST305X basic unit)					
For 5SL - 1P & 2P, 5SV - 4P and 5SM2- 2P		5ST38206	880.-	1	
For 5SL - 3P & 4P and 5SM2 - 3P & 4P		5ST38207	880.-	1	
For 5SY - 1P & 2P and For 5SU1^ - 2P, 4M		5ST38201	880.-	1	
For 5SY - 3P & 4P and For 5SU1^ - 4P, 7M		5ST38202	880.-	1	
For 5SU1 - 2P, 2M		5ST38205	880.-	1	
^ Add-on block for 5SU1 & 5SM2 to be ordered along with Adapter		5ST38203	1915.-	1	
		Handle locking device			
		for 5SP and 5SY circuit breakers for padlock with max. 3mm shackle	5ST3801	865.-	1
		for 5SL circuit breakers, 5TL1 isolators and 5SV residual current circuit breakers for padlock with max. 3 to 6 mm shackle	5ST3806	820.-	5
	Pad locks for 5ST3801 and 5ST3806 handle locking devices	5ST3802	555.-	5	
	Handle connector for 2P, 2M 5SU1 RCBO ⁵ (1set = 5 units in poly bag)	5ST38051	1725.-	1	

Betagard Rotary Handle Assembly

	Item Description	Reference No.	Unit MRP* ₹	Std. Pkg.** (Nos.)
	Rotary Handle Assembly for 5SY, 5SL, 5SP and 5TL1 series of MCBs/ Isolators ⁵⁵	5ST38140RC	3095.-	1

Note: * MRP - Maximum Retail Price # 1MW (Module Width) = 18mm

\$ For 2P, 2M RCBOs, the accessories can be used along with Handle connector only

\$\$ Not suitable for 1P variants

** Purchase MOQ for our authorized dealers is in multiples of standard packing, contact Siemens Sales Office for further details

SINOVA Opulenz

Multitasking switches for multitasking homes.

Elegant
finishes to enhance the look of your home.



Premium colours and textures
to complement modern finishes on your walls.



Antibacterial switches
for a safe home.



ISI certified
for assured safety.



Environment friendly
RoHS compliant switches.



Comprehensive communication range
type tested as per standards ensuring higher reliability.



Scan/Click
to know
more!

When homes and offices multitask as online classrooms, home offices, private theaters and more, the Opulenz range multitasks to help you make the most of them. SINOVA Opulenz is a complete range of new age sockets, HDMI receptors, LAN ports, regulators and dimmers in seven exciting colours and two natural textures.



SIEMENS



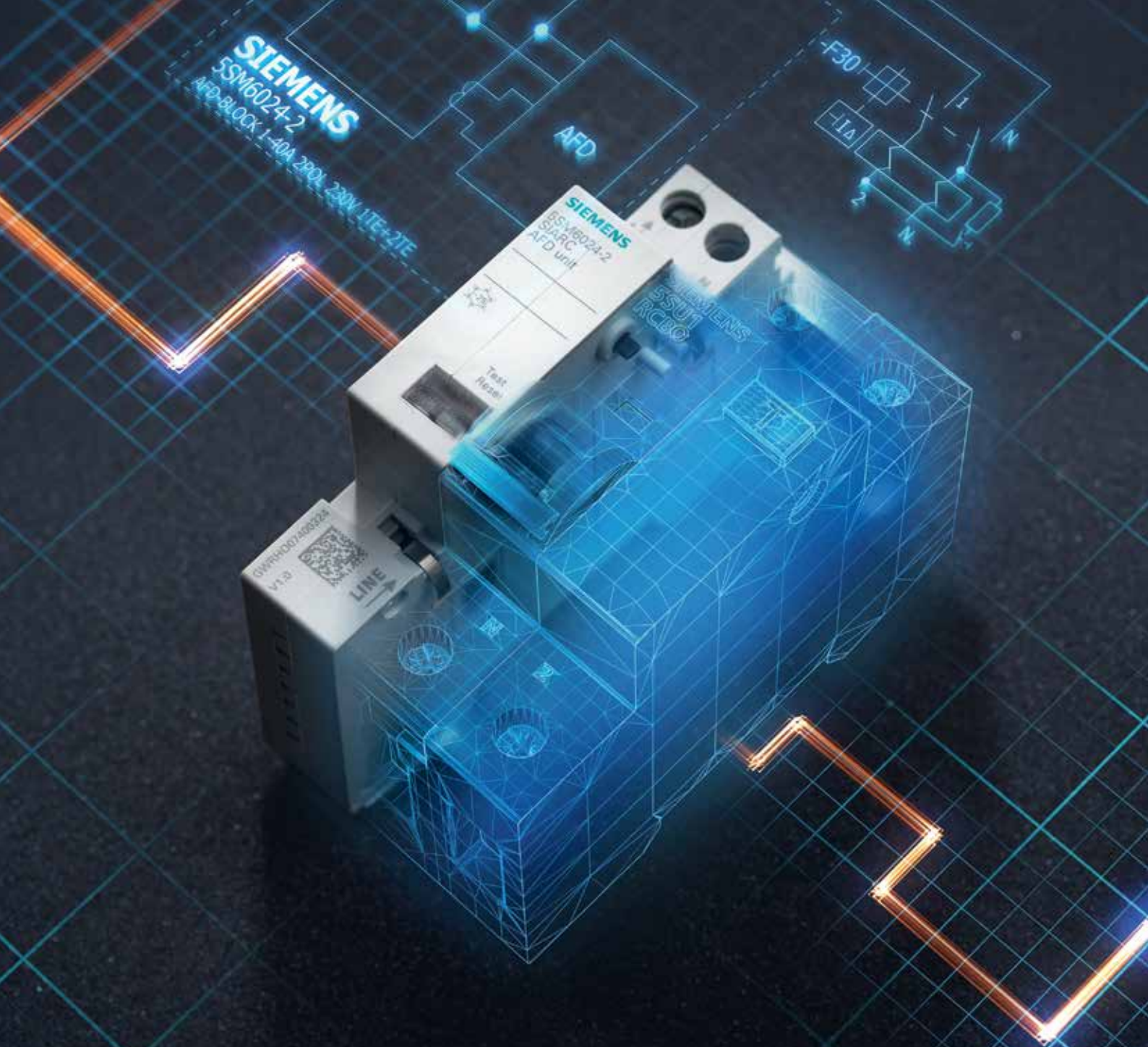

Arc Fault Detection Device

It's Time to Act Now!

With the 5SV6 Arc Fault Detection Device (AFDD), Siemens presents the third generation of fire-prevention product. The 5SV6 Arc Fault Detection Device with integrated miniature circuit breaker (MCB) is the first device on the IEC market with just one module width and is the smallest of its kind worldwide.

A standard-compliant expansion of the electrical installation by protection against electrical fires is thus always possible – easily and without the need for additional space.

www.siemens.com

SIEMENS



The smart solution.

Whether in an existing plant or a new installation – the 5SV6 AFDD and 5SM6 AFD unit can be deployed in any distribution board. It quickly identifies dangerous faults caused by parallel or serial arcing faults and switches off before a fire occurs. The AFDD detects operational arcing faults and only trips in the event of an actual fault.

5SV6 AFDDs with Integrated MCB & RCBO in 18mm width

	Rating	With integrated MCB		With integrated RCBO	Unit LP* ₹	Std. Pkg.** (Nos.)
		B characteristic	C characteristic	30mA, Type A, C characteristic		
	6A	5SV60166KK06	5SV60167KK06	5SV63167KK06	Price on Request	1
	10A	5SV60166KK10	5SV60167KK10	5SV63167KK10		
	13A	5SV60166KK13	5SV60167KK13	5SV63167KK13		
	16A	5SV60166KK16	5SV60167KK16	5SV63167KK16		
	20A	5SV60166KK20	5SV60167KK20	5SV63167KK20		
	25A	5SV60166KK25	5SV60167KK25	5SV63167KK25		
	32A	5SV60166KK32	5SV60167KK32	5SV63167KK32		
	40A	5SV60166KK40	5SV60167KK40	5SV63167KK40		

5SM6 AFDD with integrated MCB

	Rating	Module width	Reference No.	Description	Unit LP* ₹	Std. Pkg.** (Nos.)
	16A	2	5SM60111XX02	AFDD 16A, 230V, 2MW (Integrated with 1MW, 1+N, 16A MCB)	Price on Request	1

5SM6 AFD units (Suitable for add on with RCBO)

	Rating	Module width	Reference No.	Description	Unit LP* ₹	Std. Pkg.** (Nos.)
	16A	3	5SM60212	AFD Unit 1-16A, 230V, 1MW (Suitable for 2P 2M, 5SU1 RCBO)	Price on Request	1
	40A	3	5SM60242	AFD Unit 1-40A, 230V, 1MW (Suitable for 2P 2M, 5SU1 RCBO)		

* LP - List Price

** Purchase MOQ for our authorized dealers is in multiples of standard packing, contact Siemens Sales Office for further details

SIEMENS

SENTRON Circuit protection devices with measuring and communication function



**SENTRON
5SV6 COM
AFDD/MCB**



**SENTRON
Powercenter 1000
data transceiver**



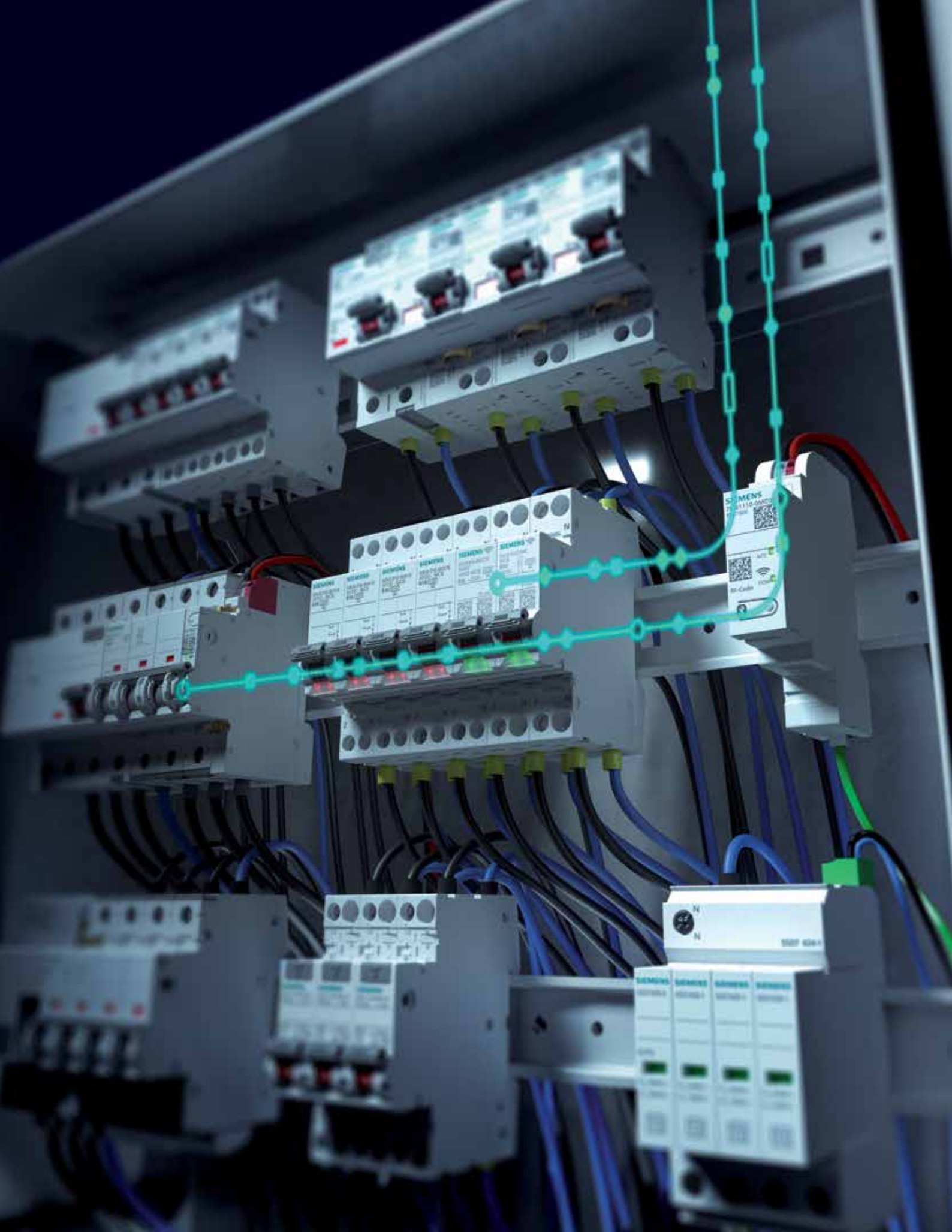

SENTRON AFDD COM 5SV6

	Rating	With integrated MCB		Unit LP* ₹	Std. Pkg.** (Nos.)
		B characteristic	C characteristic		
	6 A	5SV60166MC06	5SV60167MC06	Price on Request	1
	10 A	5SV60166MC10	5SV60167MC10		
	13 A	5SV60166MC13	5SV60167MC13		
	16 A	5SV60166MC16	5SV60167MC16		
	20 A	5SV60166MC20	5SV60167MC20		
	25 A	5SV60166MC25	5SV60167MC25		
	32 A	5SV60166MC32	5SV60167MC32		

SENTRON Powercenter 1000 7KN

	Reference No.	Description	Unit LP* ₹	Std. Pkg.** (Nos.)
	7KN11100MC00	Powercenter1000 max. 24 SENTRON COM devices Modbus TCP Bluetooth Power supply DC 24V	Price on Request	1

* LP - List Price

** Purchase MOQ for our authorized dealers is in multiples of standard packing, contact Siemens Sales Office for further details

Applications:



Operating hours counter

The values measured by the installation device provide information on the electrical consumer's (e.g., an LED) exact operating time allowing for optimized maintenance.



Fault monitoring

A decline of electrical current, voltage or temperature below normal values may hint at a failure of the electrical consumer. An increased electrical current may indicate a defect of connected equipment.



Load management

When a certain number of electrical consumers is active, additional devices cannot be switched on. This prevents current peaks.



Function monitoring

The measured values indicate the execution of an activity by the electrical consumer (e.g., automatic feeders in livestock farming).

SEAMLESS POWER TRANSITIONS, SAFEGUARDING YOUR ENERGY NEEDS

5TR4 Automatic Changeover Current Limiter



Effortlessly manage power transitions with our 5TR4 ACCL, ensuring seamless operations and preventing electrical overload.

Key Features



Heavy Duty-
Conforms to
utilization
category AC32A
(IEC 60947-6-1)



High Endurance
Cycle -Ensuring
efficient and long
life of your ACCL



Safe during Short
circuits - Iq short
circuit of 5kA

Warning &
Alerts -
Overload
indication via
LED & Beep



Standard compliant
Product conforms
to IEC 60947-6-1



Low Power
consumption -
Coil operates
only during
backup supply

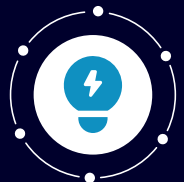

For more information-Please contact your nearest Siemens Sales Office.

SIEMENS



Betagard 8GB Distribution Boards

Perfect blend of beauty and features with assured performance







- Complete range for Residential, Commercial and Industrial Infrastructures
- DBs offer latest design with highest aesthetic appeal
- DBs available with type testing as per the latest applicable standards
- User friendly design offers ease during maintenance and assists the installer for correct installation

www.siemens.co.in

SIEMENS

Betagard Distribution Boards 8GB32 # SPN and TPN DBs

- Type Tested as per IEC 61439 Standards at third party and internal test laboratories
- Available in IP 20 and IP 43 Versions
- Single Door, Metal Double Door and Acrylic Double Door options available
- Standard Wire Way Boxes available for all Single Door and Double Door DBs
- Additional safety with Insulated Shorting Links, Shrouded Neutral Links and Door Earthing
- TPN DBs can be easily made suitable for PPI configuration using TPN to PPI Conversion Kits
- Detachable DIN rail assembly and intermittent door facilitates ease in Wiring during installation and maintenance
- DBs are subjected to Seven tank process and treated with premium quality powder coating
- Cement Masking Sheet protects the DBs against extreme site conditions

	Item Description	Incoming Slots (MW)	Outgoing Slots (MW)	Total Slots (MW)	Reference No	Unit MRP* ₹	Std. Pkg.** (Nos.)
Metal Enclosures, IP20:							
	1 Module	-	-	1	8GB32100RC01	960.-	1/20
	2 Module	-	-	2	8GB32100RC02	1430.-	1/20
	3 Module	-	-	3	8GB32100RC03	1430.-	1/20
	4 Module	-	-	4	8GB32100RC04	1430.-	1/20
	6 Module	-	-	6	8GB32100RC06	1885.-	1/20
	8 Module	-	-	8	8GB32100RC08	2220.-	1/10
SPN Single Door DBs#, IP20:							
	6 Module	2	4	6	8GB32101RC06	2825.-	1
	8 Module	2	6	8	8GB32101RC08	3000.-	1
	10 Module	2	8	10	8GB32101RC10	3610.-	1
	12 Module	2	10	12	8GB32101RC12	3740.-	1
	14 Module	2	12	14	8GB32101RC14	4225.-	1
	16 Module	2	14	16	8GB32101RC16	4555.-	1
SPN Metal Double Door DBs#, IP 43:							
	6 Module	2	4	6	8GB32102RC06	4410.-	1
	8 Module	2	6	8	8GB32102RC08	4580.-	1
	10 Module	2	8	10	8GB32102RC10	5330.-	1
	12 Module	2	10	12	8GB32102RC12	5470.-	1
	14 Module	2	12	14	8GB32102RC14	6380.-	1
	16 Module	2	14	16	8GB32102RC16	6535.-	1
SPN Acrylic Double Door DBs#, IP 43:							
	6 Module	2	4	6	8GB32103RC06	5180.-	1
	8 Module	2	6	8	8GB32103RC08	5470.-	1
	10 Module	2	8	10	8GB32103RC10	6380.-	1
	12 Module	2	10	12	8GB32103RC12	6845.-	1
	14 Module	2	12	14	8GB32103RC14	7145.-	1
	16 Module	2	14	16	8GB32103RC16	7450.-	1
Wire Way Box For SPN Single Door IP 20 DBs:							
	For 6 MOD SPN Single door DB	-	-	-	8GB32106RC06	1860.-	1/5
	For 8 MOD SPN Single door DB	-	-	-	8GB32106RC08	1860.-	1/5
	For 10 MOD SPN Single door DB	-	-	-	8GB32106RC10	2005.-	1/5
	For 12 MOD SPN Single door DB	-	-	-	8GB32106RC12	2005.-	1/5
	For 14 MOD SPN Single door DB	-	-	-	8GB32106RC14	2310.-	1/5
	For 16 MOD SPN Single door DB	-	-	-	8GB32106RC16	2310.-	1/5
Wire Way Box For SPN Double Door IP 43 DBs:							
	For 6 MOD SPN Double door DB	-	-	-	8GB32107RC06	2005.-	1/5
	For 8 MOD SPN Double door DB	-	-	-	8GB32107RC08	2005.-	1/5
	For 10 MOD SPN Double door DB	-	-	-	8GB32107RC10	2175.-	1/5
	For 12 MOD SPN Double door DB	-	-	-	8GB32107RC12	2175.-	1/5
	For 14 MOD SPN Double door DB	-	-	-	8GB32107RC14	2765.-	1/5
	For 16 MOD SPN Double door DB	-	-	-	8GB32107RC16	2765.-	1/5

Note: * MRP - Maximum Retail Price # Also available in flat door option

For Customized Solutions in Distribution Boards please Contact our sales Office

** Purchase MOQ for our authorized dealers is in multiples of standard packing, contact Siemens Sales Office for further details

Betagard Distribution Boards 8GB32 # SPN and TPN DBs

	Item Description	Incoming Slots (MW)	Outgoing Slots (MW)	Total Slots (MW)	Reference No	Unit MRP* ₹	Std. Pkg.** (Nos.)
TPN Single Door DBs#, IP20:							
	4 way	8	12	20	8GB32201RC04	7300.-	1
	6 way	8	18	26	8GB32201RC06	8290.-	1
	8 way	8	24	32	8GB32201RC08	10005.-	1
	10 way	8	30	38	8GB32201RC10	14515.-	1
	12 way	8	36	44	8GB32201RC12	14825.-	1
	14 way	8	42	50	8GB32201RC14	17000.-	1
	16 way	8	48	56	8GB32201RC16	17635.-	1
TPN Metal Double Door DBs#, IP 43							
	4 way	8	12	20	8GB32202RC04	8915.-	1
	6 way	8	18	26	8GB32202RC06	10780.-	1
	8 way	8	24	32	8GB32202RC08	12955.-	1
	10 way	8	30	38	8GB32202RC10	18715.-	1
	12 way	8	36	44	8GB32202RC12	19180.-	1
	14 way	8	42	50	8GB32202RC14	22765.-	1
	16 way	8	48	56	8GB32202RC16	23410.-	1
TPN Acrylic Double Door DBs#, IP 43							
	4 way	8	12	20	8GB32203RC04	10780.-	1
	6 way	8	18	26	8GB32203RC06	13270.-	1
	8 way	8	24	32	8GB32203RC08	15915.-	1
	10 way	8	30	38	8GB32203RC10	20760.-	1
	12 way	8	36	44	8GB32203RC12	24160.-	1
	14 way	8	42	50	8GB32203RC14	25880.-	1
	16 way	8	48	56	8GB32203RC16	27620.-	1
TPN to PPI Conversion Kit®							
	To convert 6 way TPN DB to 4 way TPN PPI DB				8GB32205RC04	5625.-	1/5
	To convert 8 way TPN DB to 6 way TPN PPI DB				8GB32205RC06	6560.-	1/5
	To convert 10 way TPN DB to 8 way TPN PPI DB				8GB32205RC08	6725.-	1/5
	To convert 12 way TPN DB to 10 way TPN PPI DB				8GB32205RC10	7180.-	1/5
	To convert 14 way TPN DB to 12 way TPN PPI DB				8GB32205RC12	7665.-	1/5
	To convert 16 way TPN DB to 14 way TPN PPI DB				8GB32205RC14	8110.-	1/5
	Wire Way Box For TPN Single Door IP 20 DBs						
	For 4 Way TPN Single door DB	-	-	-	8GB32206RC04	2375.-	1/5
	For 6 Way TPN Single door DB	-	-	-	8GB32206RC06	2375.-	1/5
	For 8 Way TPN Single door DB	-	-	-	8GB32206RC08	4240.-	1/5
	For 10 Way TPN Single door DB	-	-	-	8GB32206RC10	5330.-	1/5
	For 12 Way TPN Single door DB	-	-	-	8GB32206RC12	5480.-	1/5
	For 14 Way TPN Single door DB	-	-	-	8GB32206RC14	5625.-	1/5
	For 16 Way TPN Single door DB	-	-	-	8GB32206RC16	5960.-	1/5
Wire Way Box For TPN Double Door IP 43 DBs							
	For 4 Way TPN Double door DB	-	-	-	8GB32207RC04	2520.-	1/5
	For 6 Way TPN Double door DB	-	-	-	8GB32207RC06	2845.-	1/5
	For 8 Way TPN Double door DB	-	-	-	8GB32207RC08	4535.-	1/5
	For 10 Way TPN Double door DB	-	-	-	8GB32207RC10	4860.-	1/5
	For 12 Way TPN Double door DB	-	-	-	8GB32207RC12	5960.-	1/5
	For 14 Way TPN Double door DB	-	-	-	8GB32207RC14	6260.-	1/5
	For 16 Way TPN Double door DB	-	-	-	8GB32207RC16	6435.-	1/5

Note: * MRP - Maximum Retail Price

@ Contains required accessories to Make the DB suitable for PPI Configuration
For Customized Solutions in Distribution Boards please Contact our sales Office

** Purchase MOQ for our authorized dealers is in multiples of standard packing, contact Siemens Sales Office for further details

Also available in flat door option

Betagard Distribution Boards 8GB32 TPN Phase Segregated DBs

Item Description	Incoming Slots (MW)	Sub-Incomer Slots (MW)	Outgoing Slots (MW)	Total Slots (MW)	Reference No	Unit MRP* ₹	Std. Pkg.** (Nos.)
TPN Phase segregated DBs, IP 20 For MCB as incomer							
4 Way	12	12	12	36	8GB32001RC04	19545.-	1
6 Way	12	12	18	42	8GB32001RC06	21980.-	1
8 Way	12	12	24	48	8GB32001RC08	25660.-	1
12 Way	12	12	36	60	8GB32001RC12	30550.-	1
TPN Phase segregated DBs, (8 segment) IP 43 For MCB as incomer							
4 way	12	12	12	36	8GB32002RC04	23215.-	1
6 way	12	12	18	42	8GB32002RC06	26880.-	1
8 way	12	12	24	48	8GB32002RC08	30550.-	1
12 way	12	12	36	60	8GB32002RC12	36650.-	1
TPN Phase segregated DBs, IP 43 for MCCB as incomer upto 160A							
6 way		12	18	30	8GB32012RC06	41520.-	1
8 way		12	24	36	8GB32012RC08	47640.-	1
12 way		12	36	48	8GB32012RC12	53750.-	1
Wire Way box for MCB Incomer, IP 43 DBs							
For 4 Way	-	-	-	-	8GB32007RC04	6095.-	1
For 6 Way	-	-	-	-	8GB32007RC06	7320.-	1
For 8 Way	-	-	-	-	8GB32007RC08	8535.-	1
For 12 Way	-	-	-	-	8GB32007RC12	9760.-	1
Wire Way box for MCCB Incomer, IP 43 DBs							
For 6 Way	-	-	-	-	8GB32017RC06	7320.-	1
For 8 Way	-	-	-	-	8GB32017RC08	8535.-	1
For 12 Way	-	-	-	-	8GB32017RC12	9760.-	1

Betagard Distribution Board 8GB

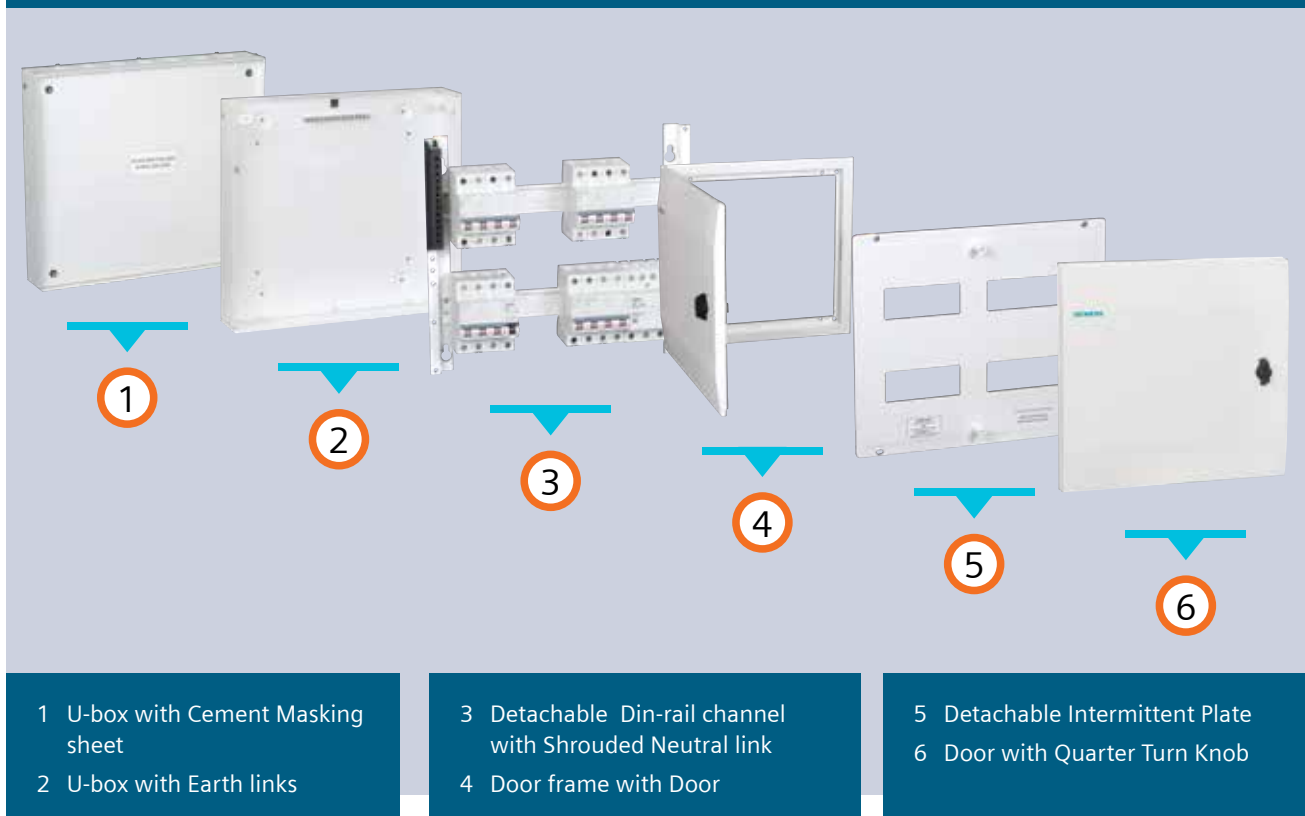

Note: * MRP - Maximum Retail Price

** Purchase MOQ for our authorized dealers is in multiples of standard packing, contact Siemens Sales Office for further details

Industrial plug & sockets

	Item Description	Total Slots (MW)	Reference No	Unit MRP* ₹	Std. Pkg.** (Nos.)
Plug & Socket, IP20 with provision for MCB mounting :					
	1 Phase 20A, 1P MCB	1	8GB0501RC	3170.-	1/20
	1 Phase 20A, 2P MCB	2	8GB0501SRC	3170.-	1/20
	3 Phase 32A, 3P MCB	3	8GB0502	6715.-	1/15
	3 Phase 32A, 3P+N MCB	4	8GB0502S	6715.-	1/15
	5 Pin (3P+N+PE) 3Phase 32A MCB 3P+N MCB	8	8GB050332	10605.-	1/5
	5 Pin (3P+N+PE) 3Phase 63A MCB 3P+N MCB	8	8GB050363	27630.-	1/5

Simbox WP

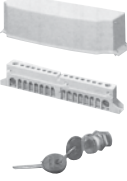
	Item Description	Total Slots (MW)	Reference No	Unit MRP* ₹	Std. Pkg.** (Nos.)
Simbox WP (IP65 DBs)					
	1 Row, 4Mod	4	8GB13710	9540.-	1
	1 Row 8Mod	8	8GB13711	12115.-	1
	1 Row 12Mod	12	8GB13712	21630.-	1
	1 Row 18Mod	18	8GB13713	28015.-	1
	2 Row 2 x 12Mod	24	8GB13722	34585.-	1
	2 Row, 2 x 18Mod	36	8GB13723	48760.-	1
	3 Row, 3 x 18Mod	54	8GB13733	85760.-	1
	4 Row 4 x 18Mod	72	8GB13743	112360.-	1
Accessories for Simbox WP					
	Coupling covers, 12M		8GB20510	3120.-	1
	Coupling covers, 18M		8GB20511	3500.-	1
	Insulated N/PE terminals, 8MW		8GB20520	4860.-	1
	Insulated N/PE terminals, 12MW		8GB20521	7435.-	1
	Insulated N/PE terminals, 18MW		8GB20522	10925.-	1
	Cylindrical security lock		8GB20550	8865.-	1





Note: * MRP - Maximum Retail Price

For Customized Solutions in Distribution Boards please Contact our sales Office

** Purchase MOQ for our authorized dealers is in multiples of standard packing, contact Siemens Sales Office for further details

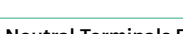

Betagard Distribution Boards Accessories

	Item Description	Reference No	Unit MRP* ₹	Std. Pkg.** (Nos.)
Blanking Plate				
	1 MW	8GB9901	120.-	25
Insulated Shorting Links				
Single Phase Shorting Links for Shorting 1P MCBs				
For SPN and TPN PPI DB				
	5 Leg SP Shorting Link	8GB9905LSP	370.-	10
	7 Leg SP Shorting Link	8GB9907LSP	435.-	10
	9 Leg SP Shorting Link	8GB9909LSP	510.-	10
	11 Leg SP Shorting Link	8GB9911LSP	535.-	10
	13 Leg SP Shorting Link	8GB9913LSP	720.-	10
	15 Leg SP Shorting Link	8GB9915LSP	870.-	10
	17 Leg SP Shorting Link	8GB9917LSP	915.-	10
For TPN DB				
	4 Leg SP Shorting Link	8GB9904LSP	370.-	10
	6 Leg SP Shorting Link	8GB9906LSP	435.-	10
	8 Leg SP Shorting Link	8GB9908LSP	510.-	10
	10 Leg SP Shorting Link	8GB9910LSP	535.-	10
	12 Leg SP Shorting Link	8GB9912LSP	720.-	10
	14 Leg SP Shorting Link	8GB9914LSP	870.-	10
	16 Leg SP Shorting Link	8GB9916LSP	915.-	10
Two Phase, 1 meter long for shorting 2P MCBs (suitable for maximum of 28 nos. 2MW devices)				
	Shorting link without End caps, Can be cut and used.	8GB990SLDLP	9040.-	1
	End Caps for 2 pole Shorting Links	8GB990ECLDP	150.-	10
Three Phase, 1 meter long for shorting 3P MCBs (suitable for maximum of 19 nos. 3MW devices)				
	Shorting link without Enc caps, Can be cut and used.	8GB990SLTLP	9890.-	1
	End Caps for 3 pole Shorting Links	8GB990ECLTP	220.-	10
Three Phase + N, 1 meter long for shorting TPN MCBs (suitable for maximum of 14 nos. 4MW devices)				
	Shorting link without Enc caps, Can be cut and used.	8GB990SLTPN	10455.-	1
	End Caps for 3 pole Shorting Links	8GB990ECLTPN	280.-	10
Neutral Terminals				
Neutral Terminals For 8GB0 and 8GB31 DBs (Along with Mounting Stands)				
	5 Way Neutral Link	8GB9905NL	400.-	10
	11 Way Neutral Link	8GB9911NL	590.-	10
	13 Way Neutral Link	8GB9913NL	670.-	10
	15 Way Neutral Link	8GB9915NL	755.-	10
Neutral Terminals For 8GB32 DBs (With Terminal Shroud and Cover)				
	Neutral Terminal 5 Holes	8GB9905NPE	435.-	10
	Neutral Terminal 11 Holes	8GB9911NPE	600.-	10
	Neutral Terminal 13 Holes	8GB9913NPE	720.-	10
	Neutral Terminal 15 Holes	8GB9915NPE	795.-	10
Earth Terminals				
	5 Way Earth Link	8GB9905EL	335.-	10
	11 Way Earth Link	8GB9911EL	565.-	10
	13 Way Earth Link	8GB9913EL	600.-	10
	15 Way Earth Link	8GB9915EL	720.-	10

Note: * MRP - Maximum Retail Price

** Purchase MOQ for our authorized dealers is in multiples of standard packing, contact Siemens Sales Office for further details

DISCOVER THE POWER OF **SIMPLICITY**

SINOVA low-voltage electrical products



Cost-effective
Best price performance ratio



Comprehensive range
For various applications



Reliable
Siemens trusted quality

IEC

Safe
Complies with IEC standards



www.siemens.co.in

Learn more about our low-voltage electrical products or contact us for a personalized consultation and take the first step towards an efficient power future.



SIEMENS



5SD Surge Protection Devices

Safe & Reliable

Surge Protection Devices are available in the following types:

Type 1 - For incoming power supply panels, in buildings with lightning protection system. Must be accompanied by downstream SPD

Type 2 - For distribution panels located downstream of Type 1 protectors or in incoming supply panels in areas of low exposure to lightning strikes, where the building is not fitted with lightning protection system

Type 3 - Always installed downstream of Type 2 protection designed to protect sensitive equipment or equipment located more than 20m downstream of Type 2 SPD

Surge Protection Devices

For protection of equipment against Lightning and Switching surges

- Standard: IEC 61643-11 / EN 61643-11
- Type 1, Type 2 and Photovoltaic surge protection
- With Remote signaling contact
- Integrated SPD health indicator

Type 1: Lightning Surge Arresters

- Maximum continuous operating voltage U_c : 350V



Reference No.	Rated voltage	Pole	Module width	Total I_{imp} (10/350 μ s)	I_{max} (8/20 μ s)	Remote status	Unit LP* ₹
5SD74121RC	240V AC	1P+N	4	50kA	50kA	Yes	24970.-
5SD74141RC	240/415V AC	3P+N	8	100kA	50kA	Yes	48600.-

Type 2: Surge Arresters



Reference No.	Rated voltage	Pole	Module width	U_c	I_{max} (8/20 μ s)	Remote status	Unit LP* ₹
5SD74610RC	240V AC	1P	1	335V AC	20kA	No	4080.-
5SD74640RC	240/415V AC	3P+N	4	335V AC	40kA	No	12135.-

Surge Arresters for Photovoltaic application

On the DC side, over voltage protection is required for the inverters which can be ensured by using 5SD74836RC.

On the AC side, the over voltage protection can be ensured using surge arresters Type 2 (5SD7461-0RC/5SD7464-0RC)



Reference No.	Rated voltage	Pole	Module width	U_{cpv}	I_{max} (8/20 μ s)	Remote status	Unit LP* ₹
5SD74836RC	1170V DC	L+ and L-	3	1170V DC	40kA	No	6895.-

Note: Standard packing: 1 unit

*LP: List Price



Surge Protection Devices

For protection of equipment against Lightning and Switching surges

Type 1: Lightning Surge Arresters

For TN-S/ TT system

Lightning arresters, Type 1 requirement class B, U_c 350V Pluggable protective modules 4-pole, 3+1 circuit for TN-S and TT systems with remote display



5SD74121



5SD74141

Rated voltage U_N	Backup fuse rating	Protection level	Lightening impulse current $I_{mp}(10/350\mu s)$		Pole	Reference No.	Unit LP* ₹
			L-N or L-(PE), 1P/3P	N-PE			
240V AC	125A gL/gG	1.5-2.5kV	25kA	100kA	1P+N	5SD74121	89890.-
240/415V AC	125A gL/gG	1.5-2.5kV	25kA/75kA	100kA	3P+N	5SD74141	152485.-

For TN-C system

Lightning arresters, Type 1 requirement class B, U_c 350V Pluggable protective modules 3-pole, 3+0 circuit for TNC systems with remote display



5SD74131

Rated voltage U_N	Backup fuse rating	Protection level	Lightening impulse current $I_{mp}(10/350\mu s)$		Pole	Reference No.	Unit LP* ₹
			L-N or L-(PE), 1P/3P	N-PE			
240/415V AC	125A gL/gG	$\leq 1.5kV$	25kA/75kA	-	3P	5SD74131	119285.-

Type 2 : Surge Arresters

For TN-S/ TT system

Surge arrester Type 2 requirement class C, U_c :350V/260V (L-N/N-PE) Pluggable protective modules 4-pole, 3+1 circuit for TN-S and TT AC systems

Rated Discharge Surge Current $I_n=20kA$ SC capacity with backup fuse=25kA



5SD74641



5SD7422-0

Rated voltage U_N	Backup fuse rating	Protection level U_p	Rated discharge current I_n (8/20usec)		Pole	Remote signaling	Reference No.	Unit LP* ₹
			L-N or L-(PE), 1P/3P	N-PE				
240/415V	80A gL/gG	1.5-1.9kV	40kA	40kA	3P+N	No	5SD74640	47260.-
240/415V	80A gL/gG	1.5-1.9kV	40kA	40kA	3P+N	Yes	5SD74641	34870.-
240V	80A gL/gG	1.5-1.9kV	20kA	20kA	1P+N	No	5SD74220	27400.-
240V	80A gL/gG	1.5-1.9kV	20kA	20kA	1P+N	Yes	5SD74221	30250.-

For TN-C system

Surge arrester Type 2 requirement class C, U_c :350V Pluggable protective modules 3-pole, 3+0 circuit for TNC systems



5SD7463-0

Rated voltage U_N	Backup fuse rating	Protection level U_p	Maximum discharge surge current I_{max}	Pole	Remote signaling	Reference No.	Unit LP* ₹
			L-N or L-(PE)N, 1P				
240/415V	80A gL/gG	$\leq 1.5kV$	40kA	3P	No	5SD74630	40420.-
240/415V	80A gL/gG	$\leq 1.5kV$	40kA	3P	Yes	5SD74631	42270.-

L - Line, N - Neutral, PE - Protective Earth

Note: Standard packing: 1unit

* LP : List Price

Surge Protection Devices

For protection of equipment against Lightning and Switching surges

Type 3 : Surge Arresters

	Rated voltage	Rated current	Protection level	Rated discharge current	Pole	Reference No.	Unit LP* ₹
	24V AC 34V DC	26A	0.65kV	1kA	2P	5SD74325	19160.-
	120V AC 150V DC	26A	0.95kV	3kA	2P	5SD74326	20875.-
	240V AC 240V DC	26A	1.5kV	3kA	2P	5SD74327	21435.-

Surge arresters for photovoltaic application

Due to the combination of three power varistors, the overvoltage protection required for the inverters is implemented on the DC side. On the AC side, the overvoltage protection can be ensured using surge arresters type 2 (5SD7422-/5SD7424-)

	Rated voltage U _N	Rated discharge current	Protection level U _p	Lightning Impulse current (L-N/L-(PE)N)	Max. discharge current	Pole	Remote signaling	Reference No.	Unit LP* ₹
 5SD74836	1000V DC	15kA	≤3.5kV	≤5kA	40kA	3P	No	5SD74836	39740.-

Replacement Plug

	SPD Type	Type	Connection	Reference No.	Unit LP* ₹
	5SD74121	Type 1	L-N	5SD74181	33630.-
	5SD74131				
	5SD74141				
	5SD74121	Type 2	N-PE	5SD74180	35250.-
	5SD74131				
	5SD74141				
5SD7463-0/1	Type 2	L-N	5SD74681	9875.-	
5SD7464-0/1		N-PE	5SD74880	12385.-	
5SD7422-0/1		L-N	5SD74281	9875.-	
5SD7422-0/1		N-PE	5SD74280	12860.-	
5SD7483-6	PV			5SD74983	10465.-

* Also available Type 1+ Type 2 and Type1/2 Compact SPDs for protection against overvoltages from Lightning strikes as well as by switching operations in network

Note:

Standard packing: 1unit

* LP - List Price



SENTRON Modular Devices



For efficient control and monitoring

- 7LF time switch - Digital and Analog timers for all applications; available in Mini, Top, Profi, Astro, Expert and Expert GPS variants
- 5TT5 insta contactors – For all control applications; also with Manual/Automatic switching indicator
- DIN mounted phase indicators, monitoring relays and measuring devices for final distribution circuits
- Twilight Switch for Automatic Street Light Control

www.siemens.co.in

SIEMENS

Modular Devices

	Item Description	Rated Current I_n (A)	MW#	Reference No	Unit LP* ₹	Std. Pkg.** (Nos.)
Changeover switches						
Standards: IEC 60947-3/DIN EN 60947-3						
	1C/O, 230V	20	1	5TE8161	4150.-	1/10
	2C/O, 400V	20	1	5TE8162	6270.-	1/10
	Group switch, center position, 2C/O, 400V	20	1	5TE8142	7575.-	1/10
Insta Contactors						
Standards: EN 60947-4-1, EN 60947-5-1						
	2NO contacts, 230V AC	20	1	5TT58000	5010.-	1/5
	3NO+1NC contacts, 230V AC/220V DC (1NC contact rated for 30A)	40	3	5TT58410	13700.-	1/5
	3NO+1NC contacts, 24V AC/24V DC (1NC contact rated for 30A)	40	3	5TT58412	13765.-	1/5
	4NO contacts, 230V AC/220V DC	40	3	5TT58400	13805.-	1/5
	4NO contacts, 24V AC/24V DC	40	3	5TT58402	13785.-	1/5
	3NO+1NC contacts, 230V AC/220V DC (1NC contact rated for 30A)	63	3	5TT58510	21450.-	1/5
	3NO+1NC contacts, 24V AC/24V DC, (1NC contact rated for 30A)	63	3	5TT58512	21840.-	1/5
	4NO contacts, 230V AC/220V DC	63	3	5TT58500	17495.-	1/5
	4NO contacts, 24V AC/24V DC	63	3	5TT58502	17530.-	1/5
Insta Contactors Manual / Automatic with Switching Indicator						
Standards: IEC60947-4-1, IEC60947-5-1						
	2NO contacts, 230V AC	20	1	5TT58006	6665.-	1/5
	1NO+1NC contacts, 230V AC	20	1	5TT58016	9800.-	1/5
	4NO contacts, 230V AC	25	2	5TT58306	10075.-	1/5
	4NO contacts, 400V AC	40	3	5TT58406	20280.-	1/5
	4NO contacts, 400V AC	63	3	5TT58506	26570.-	1/5
Accessories						
	Control Switch with 1 Make and 1 Break Contact For AC 230V/400V For 5TT58 and 5TT50			5TT59101	6110.-	1/10





Note:

* LP - List Price # 1MW (Module Width) = 18mm

** Purchase MOQ for our authorized dealers is in multiples of standard packing, contact Siemens Sales Office for further details



Modular Devices



	Item Description	Rated Current I _n (A)	MW#	Reference No	Unit LP* ₹	Std. Pkg.** (Nos.)
Twilight switch						
	Twilight Switch with light sensor 230 V, 50/60 Hz, 1MW, 16A			7LQ2300	54965.-	1
Voltage Relays Standards: IEC 60255, DIN VDE 0435-303						
	Voltage relay for undervoltage monitoring of 1,2,3 phases against N with phase failure detection, Switching thresholds 0.7-0.9xV, not adjustable; 2 C/O contacts, 4A, 230/400V AC	4	2	5TT3402	22195.-	1
	Voltage relay for undervoltage monitoring of 1,2,3 phases against N, short time failure detection with phase failure detection and N conductor monitoring, Switching thresholds 0.8-0.85xV, not adjustable; 2 C/O contacts, 230/400V AC	4	2	5TT3407	40605.-	1
	Voltage relay for over and undervoltage monitoring of 3 phases against N with asymmetry, reverse voltage and phase failure detection with N conductor monitoring and adj. Time delay of 0.1 to 20s, Switching thresholds: U/voltage 0.7-1.1xV, 4% hysteresis, adjustable, O/voltage 0.9-1.1xV, 4% hysteresis, adjustable; 2 C/O contacts, 230/400V AC	4	2	5TT3408	41800.-	1
RYG 3 phase indicator in 1MW						
	3 phase indicator (all with green color cap)		1	5TE5802	5580.-	1/10
	3 phase indicator (red/yellow/green)		1	5TE5803	5310.-	1/10
	Transparent cap (1 set = 3 items, R, Y, G lens)			5TG8070	1425.-	1/10
Power ON Indicator (Economy Version) 230 V AC, 1 Phase						
	Light indicators for max. cable length up to 5 m with 1 red lamp		1	5TE5800	3330.-	1/12
	Light indicators for max. cable length up to 250 m with 1 red lamp		1	5TE5804	4230.-	1/12
	Transparent cap (Red) (1 set 5x each red/transparent)			5TG8061	1840.-	5
	Transparent cap (Green) (1 Set with 5x each green/transparent)			5TG8062	1840.-	5
	Transparent cap (Yellow) (1 Set with 5x each yellow/transparent)			5TG8063	1840.-	5
	Transparent cap (Blue) (1 Set with 5x each blue/transparent)			5TG8064	1840.-	5
Fuse Monitor						
	Fuse monitors with transparent caps for all low voltage fuse systems, 230V AC	4	2	5TT3170	17410.-	1

Note:

* LP - List Price # 1MW (Module Width) = 18mm

** Purchase MOQ for our authorized dealers is in multiples of standard packing, contact Siemens Sales Office for further details

Modular Devices

	Item Description	Rated Current I_n (A)	MW#	Reference No	Unit LP* ₹	Std. Pkg.** (Nos.)
Time Switches (Digital)						
	Mini digital, daily/weekly program, 100 hours reserve, 230V AC	16	1	7LF45015	12960.-	1
	Yearly time switch top digital 230V, 1 channel	16	2	7LF45110	15870.-	1
	Yearly time switch top digital 230V, 2 channel	16	2	7LF45120	30380.-	1
	Weekly time switch profi digital 230V, 1 channel	16	2	7LF45210	28300.-	1
	Weekly time switch profi digital 230V, 2 channel	16	2	7LF45220	36605.-	1
	Weekly time switch astro digital 230V, 1 channel	16	2	7LF45310	28530.-	1
	Weekly time switch astro digital 230V, 2 channel	16	2	7LF45320	47700.-	1
Time Switches (Mechanical) Standards: EN 60730-1						
 7LF53005	Quartz time switch Day 1 NO 230V/50-60Hz 1 MW with power reserve	16	1	7LF53011	17560.-	1
	Synchronous time switches without power reserve, for DIN rail mounting, day disk, 1CO, 230V AC	16	3	7LF53005	9690.-	1
	Quartz-clock time switches with power reserve for DIN rail mounting, day disk, 1CO, 230V AC	16	3	7LF53016	18650.-	1
	Quartz-clock time switches with power reserve for wall mounting, day disk, 1CO, 250V AC	16	—	7LF53050	20400.-	1
	Synchronous time switches without power reserve, for wall mounting, day disk, 1CO, 250V AC	16	—	7LF53010	11500.-	1
Accessories for Digital Time Switches						
	USB adapter and software			7LF49410	46965.-	1
	Data key profi, astro			7LF49411	4780.-	1

Note:

* LP - List Price

1MW (Module Width) = 18mm

** Purchase MOQ for our authorized dealers is in multiples of standard packing, contact Siemens Sales Office for further details



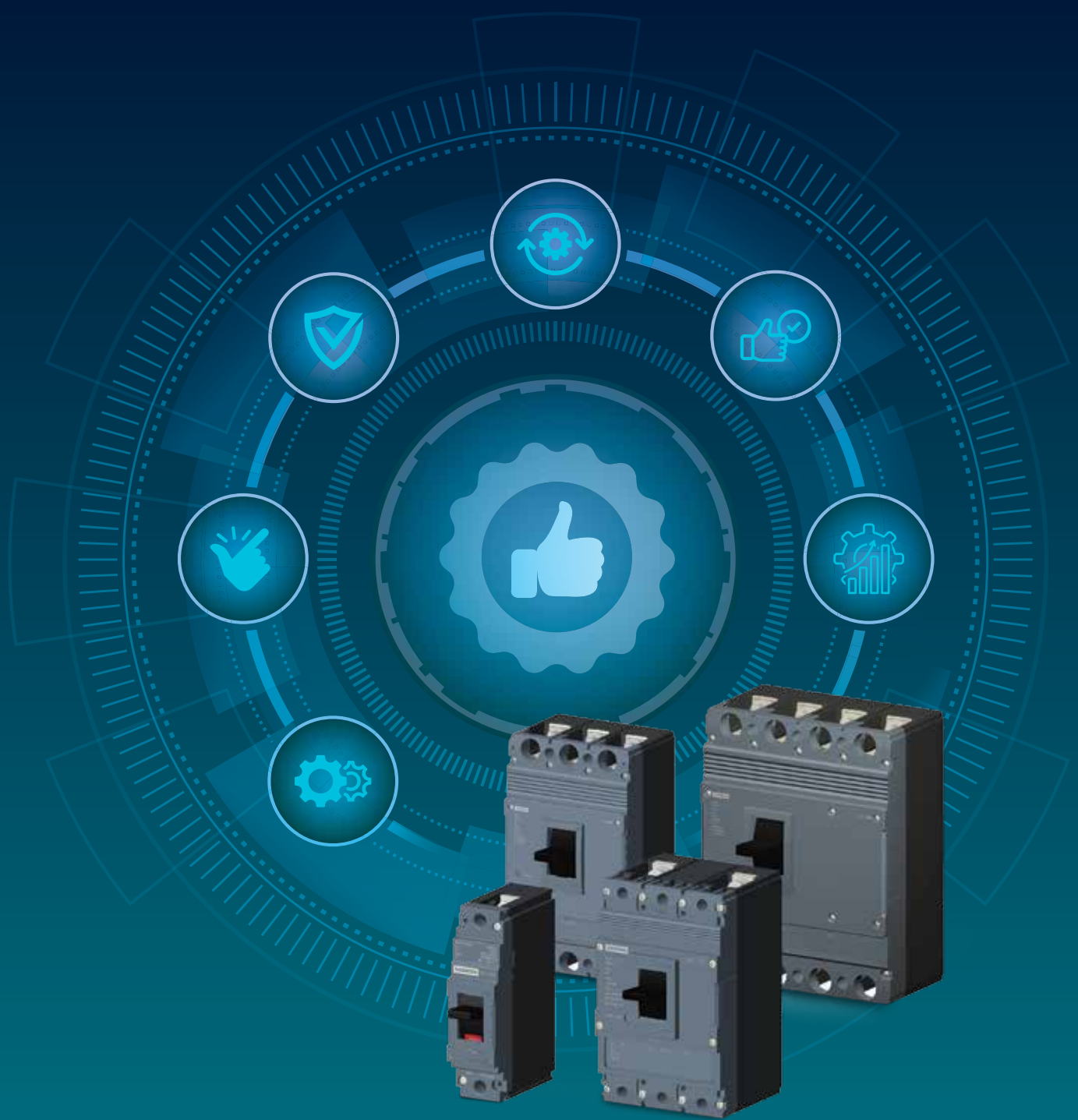

SINOVA

3VJ Moulded Case Circuit Breakers

Simply Efficient

- Rated current: 16A to 630A
- 1 pole, 2 pole, 3 pole & 4 pole versions
- Breaking capacity: 10kA to 55kA
- Thermal magnetic trip unit (FTFM, ATFM)
- Range of internal and external accessories

www.siemens.co.in

SIEMENS

3VJ Moulded Case Circuit Breakers^{\$}

3VJ MCCB, Thermal Magnetic Trip Unit, Fixed Thermal Fixed Magnetic (FTFM), 415V AC, 50Hz

Frame Size	Breaking Capacity @415V AC, 50/60Hz	Rated Current In (A)	3 Pole Type	4 Pole Type		
3VJ10 (VJ1 125X)	18kA	16	3VJ1096-1DA32-0AA0	3VJ1096-1EA42-0AA0		
		20	3VJ1002-1DA32-0AA0	3VJ1002-1EA42-0AA0		
		25	3VJ1092-1DA32-0AA0	3VJ1092-1EA42-0AA0		
		32	3VJ1003-1DA32-0AA0	3VJ1003-1EA42-0AA0		
		40	3VJ1004-1DA32-0AA0	3VJ1004-1EA42-0AA0		
		50	3VJ1005-1DA32-0AA0	3VJ1005-1EA42-0AA0		
		63	3VJ1006-1DA32-0AA0	3VJ1006-1EA42-0AA0		
		80	3VJ1008-1DA32-0AA0	3VJ1008-1EA42-0AA0		
		100	3VJ1010-1DA32-0AA0	3VJ1010-1EA42-0AA0		
		125	3VJ1012-1DA32-0AA0	3VJ1012-1EA42-0AA0		
		3VJ12 (VJ1 250)	25kA	16	3VJ1096-3DA32-0AA0	3VJ1096-3EA42-0AA0
				20	3VJ1002-3DA32-0AA0	3VJ1002-3EA42-0AA0
				25	3VJ1092-3DA32-0AA0	3VJ1092-3EA42-0AA0
				32	3VJ1003-3DA32-0AA0	3VJ1003-3EA42-0AA0
40	3VJ1004-3DA32-0AA0			3VJ1004-3EA42-0AA0		
50	3VJ1005-3DA32-0AA0			3VJ1005-3EA42-0AA0		
63	3VJ1006-3DA32-0AA0			3VJ1006-3EA42-0AA0		
80	3VJ1008-3DA32-0AA0			3VJ1008-3EA42-0AA0		
100	3VJ1010-3DA32-0AA0			3VJ1010-3EA42-0AA0		
125	3VJ1012-3DA32-0AA0			3VJ1012-3EA42-0AA0		
3VJ12 (VJ1 250)	25kA			160	3VJ1216-3DA32-0AA0	3VJ1216-3EA42-0AA0
				200	3VJ1220-3DA32-0AA0	3VJ1220-3EA42-0AA0
				250	3VJ1225-3DA32-0AA0	3VJ1225-3EA42-0AA0

3VJ MCCB, Thermal Magnetic Trip Unit, Adjustable Thermal Fixed Magnetic (ATFM), 415V AC, 50Hz

Frame Size	Breaking Capacity @415V AC, 50/60Hz	Rated Current In (A)	3 Pole Type	4 Pole Type
3VJ10 (VJ1 125X)	25kA	16	3VJ1096-3DB32-0AA0	3VJ1096-3EB42-0AA0
		20	3VJ1002-3DB32-0AA0	3VJ1002-3EB42-0AA0
		25	3VJ1092-3DB32-0AA0	3VJ1092-3EB42-0AA0
		32	3VJ1003-3DB32-0AA0	3VJ1003-3EB42-0AA0
		40	3VJ1004-3DB32-0AA0	3VJ1004-3EB42-0AA0
		50	3VJ1005-3DB32-0AA0	3VJ1005-3EB42-0AA0
		63	3VJ1006-3DB32-0AA0	3VJ1006-3EB42-0AA0
		80	3VJ1008-3DB32-0AA0	3VJ1008-3EB42-0AA0
		100	3VJ1010-3DB32-0AA0	3VJ1010-3EB42-0AA0
		125	3VJ1012-3DB32-0AA0	3VJ1012-3EB42-0AA0
3VJ12 (VJ1 250)	25kA	160	3VJ1216-3DB32-0AA0	3VJ1216-3EB42-0AA0
		200	3VJ1220-3DB32-0AA0	3VJ1220-3EB42-0AA0
		250	3VJ1225-3DB32-0AA0	3VJ1225-3EB42-0AA0
3VJ13 (VJ1 400)	25kA	320	3VJ1332-3DB32-0AA0	3VJ1332-3EB42-0AA0
		400	3VJ1340-3DB32-0AA0	3VJ1340-3EB42-0AA0
3VJ11 (VJ1 125)	36kA	16	3VJ1196-5DB32-0AA0	3VJ1196-5EB42-0AA0
		20	3VJ1102-5DB32-0AA0	3VJ1102-5EB42-0AA0
		25	3VJ1192-5DB32-0AA0	3VJ1192-5EB42-0AA0
		32	3VJ1103-5DB32-0AA0	3VJ1103-5EB42-0AA0
		40	3VJ1104-5DB32-0AA0	3VJ1104-5EB42-0AA0
		50	3VJ1105-5DB32-0AA0	3VJ1105-5EB42-0AA0
		63	3VJ1106-5DB32-0AA0	3VJ1106-5EB42-0AA0
		80	3VJ1108-5DB32-0AA0	3VJ1108-5EB42-0AA0
		100	3VJ1110-5DB32-0AA0	3VJ1110-5EB42-0AA0
		125	3VJ1112-5DB32-0AA0	3VJ1112-5EB42-0AA0
3VJ12 (VJ1 250)	36kA	160	3VJ1216-5DB32-0AA0	3VJ1216-5EB42-0AA0
		200	3VJ1220-5DB32-0AA0	3VJ1220-5EB42-0AA0
		250	3VJ1225-5DB32-0AA0	3VJ1225-5EB42-0AA0
3VJ13 (VJ1 400)	36kA	320	3VJ1332-5DB32-0AA0	3VJ1332-5EB42-0AA0
		400	3VJ1340-5DB32-0AA0	3VJ1340-5EB42-0AA0
3VJ14 (VJ1 630)	36kA	630	3VJ1463-5DB32-0AA0	3VJ1463-5EB42-0AA0

^{\$} Kindly refer latest Power Distribution Products Price List for prices

3VJ Internal accessories⁵

Frame Size	Accessory compartment/ Coil voltage	3VJ10 (VJ1 125X)	3VJ11 (VJ1 125)	3VJ12 (VJ1 250)	3VJ13/14 (VJ1 400/630)
Auxiliary Switches (AUX)	Left	3VJ9018-0AN11	3VJ9218-0AN11	3VJ9218-0AN11	3VJ9417-0AN11
	Right	-	3VJ9218-0AN21	3VJ9218-0AN21	3VJ9417-0AN21
Auxiliary + Alarm Switches (AUX+AL)	Left	3VJ9018-0AD11	3VJ9118-0AD11	3VJ9218-0AD11	3VJ9417-0AD11
	Right	-	3VJ9118-0AD21	3VJ9218-0AD21	3VJ9417-0AD21

3VJ External accessories⁵

Frame Size	Accessory	3VJ10 (VJ1 125X)	3VJ11 (VJ1 125)	3VJ12 (VJ1 250)	3VJ13/14 (VJ1 400/630)
	Extended Door Mounted Rotary Operator (including 8UC handle)	3VJ9018-0HD11	3VJ9118-0HD11	3VJ9218-0HD11	3VJ9417-0HD11
	Enclosure	3VJ9016-ODE11 (2P, 3P)	3VJ9116-ODE11 (2P, 3P)	3VJ9216-ODE12 (2P, 3P)	-
		3VJ9014-ODE11 (4P)	3VJ9114-ODE11 (4P)	3VJ9214-ODE12 (4P)	-

Raja⁺ DOL Starters[@] 3TW Direct On Line Starters



3ph, 50Hz DOL Starter in sheet steel housing, including bimetal relay with single phasing protection

	Motor Rating At 415V 3ph 50Hz		Starter Type	Contactors	Thermal Overload Relay	Relay range (A)	Max. Full Load Current (Amp)		Std. Pkg. (Nos.)
	HP	kW					3Ph, 415V 4P Squirrel Cage IS 8789:1996 Table 4	3Ph, 415V 2P MRP Submersible motor IS 9283:1995 Table 2	
	0.33	0.25	3TW7291-1A^64	3TS3010-0A##-08KA0	3UW5102-0J	0.63-1	-	-	1
	0.75	0.55	3TW7291-1A^66	3TS3010-0A##-08KA0	3UW5102-1A	1-1.6	1.7	-	1
	1	0.75	3TW7291-1A^68	3TS3010-0A##-08KA0	3UW5102-1C	1.6-2.5	2.2	-	1
	1.5	1.1	3TW7291-1A^69	3TS3010-0A##-08KA0	3UW5102-1D	2-3.2	2.9	3.25	1
	2	1.5	3TW7291-1A^71	3TS3010-0A##-08KA0	3UW5102-1F	3.2-5	3.8	4.5	1
	3	2.2	3TW7291-1A^72	3TS3010-0A##-08KA0	3UW5102-1G	4-6.3	5.1	6.5	1
	5	3.7	3TW7291-1A^74	3TS3010-0A##-08KA0	3UW5102-1J	6.3-10	8.1	10	1
	7.5	5.5	3TW7291-1A^75	3TS3210-0A##-08KA0	3UW5102-1K	8-12.5	11.4	14.5	1
	7.5	5.5	3TW7291-1A^77	3TS3210-0A##-08KA0	3UW5102-2A	10-16	-	-	1
	10	7.5	3TW7291-1A^78	3TS3210-0A##-08KA0	3UW5102-2B	12.5-20	15.4	19.5	1

^ Enter code for coil voltage, 50Hz (B for 200-400V AC, W for 332 - 456V AC)

Enter Code for operating coil voltage, 50 Hz (Z6 for 200-400V, R0 for 415V)

* MRP - Maximum Retail Price LP - List Price

\$ Kindly refer latest Power Distribution Products Price List for prices

@ Kindly refer latest Control Products Price List for prices

Switch disconnecter fuse[@] Superswitch 3KL8 in open execution 3PN

Switch Disconnector fuse: 3KL8 for power distribution (in Open Execution 3PN)[^]

	Rated current Ie @ 690V AC 50Hz	SDF suitable for DIN type HRC Fuses	SDF suitable for BS type HRC Fuses	SDF suitable for cylindrical type HRC Fuses	Std. pkg. (nos.)
	20A	3KL8111-5TA00	3KL8111-5TJ00	3KL8111-5TC00	1
	32A	3KL8121-5TA00	3KL8121-5TJ00	3KL8121-5TC00	1
	63A	3KL8151-5TA00	3KL8151-5TJ00	3KL8151-5TC00	1
	100A	3KL8171-5TA00	-	-	1
	100A	3KL8211-5TA00	3KL8211-5TJ00	-	1
	125A	3KL8221-5TA00	3KL8221-5TJ00	-	1
	160A	3KL8231-5TA00	3KL8231-5TJ00	-	1
	200A	3KL8311-5UA00	3KL8311-5UJ00	-	1
	250A	3KL8321-5UA00	3KL8321-5UJ00	-	1
	315A	3KL8331-5UA00	3KL8331-5UJ00	-	1
	400A	3KL8341-5UA00	3KL8341-5UJ00	-	1
	500A	3KL8411-5UA00	3KL8411-5UJ00	-	1
	630A	3KL8421-5UA00	3KL8421-5UJ00	-	1
	800A	3KL8431-5UA00	3KL8431-5UJ00	-	1

[^] 3PN is 3 Pole with neutral link

Selection table for SS Housing for 3KL8



	Rated current Ie (A)	Reference No	Unit MRP* ₹	Std. Pkg. (Nos.)
	3KL81 (20A - 63A)	3KX8235-4AC	-	1
	3KL82 (100A - 160A)	3KX8235-4AC	-	1
	3KL83 (200A - 400A)	3KX8345-4AC	-	1
	3KL84 (500A - 800A)	3KX8435-4AC	-	1

Rated current Ie (A)	Gland box Reference No.	Unit MRP* ₹	Gland Plate Reference No.	Unit MRP* ₹	Std Pkg. (Nos.)
3KL81(20A-63A)	3KX8235-4DC	-	3KX8235-4GC	-	1
3KL82(100A-160A)	3KX8235-4DC	-	3KX8235-4GC	-	1
3KL83(200A-400A)	3KX8345-4DC	-	3KX8345-4GC	-	1
3KL84(500A-800A)	3KX8435-4DC	-	3KX8435-4GC	-	1

LV HRC Fuses[@]

DIN Type Fuse



Rated voltage: 500 V AC

	Size	Rated current A	Reference No	Unit MRP* ₹	Std. Pkg. (Nos.)
	000	2	3NA7 802-ORC	-	1/6
		4	3NA7 804-ORC	-	
		6	3NA7 801-ORC	-	
		10	3NA7 803-ORC	-	
		16	3NA7 805-ORC	-	
		20	3NA7 807-ORC	-	
		25	3NA7 810-ORC	-	
		32	3NA7 812-ORC	-	
		40	3NA7 817-ORC	-	
		50	3NA7 820-ORC	-	
	00	63	3NA7 822-ORC	-	
		80	3NA7 824-ORC	-	
		100	3NA7 830-ORC	-	
		125	3NA7 832-ORC	-	
	1	160	3NA7 836-ORC	-	
		50	3NA7 120-ORC	-	1/3
		63	3NA7 122-ORC	-	
		80	3NA7 124-ORC	-	
		100	3NA7 130-ORC	-	
		125	3NA7 132-ORC	-	
		160	3NA7 136-ORC	-	
		200	3NA7 140-ORC	-	
		224	3NA7 142-ORC	-	
250	3NA7 144-ORC	-			

400 & 800A fuses - Rated voltage at 415 V AC

Note: * MRP - Maximum Retail Price

@ Kindly refer latest Power Distribution Products Price List for prices





	Size	Rated current A	Reference No	Unit MRP* ₹	Std. Pkg. (Nos.)
	2	200	3NA7 240-ORC	-	1/3
		250	3NA7 244-ORC	-	
		315	3NA7 252-ORC	-	
		400 [#]	3NA7 260-ORC	-	
	3	315	3NA3 352-ORC	-	1/3
		400	3NA3 360-ORC	-	
		500	3NA3 365-ORC	-	
		630	3NA3 372-ORC	-	
		800 [#]	3NA3 375-4RC	-	

BS Fuses

	Type	Rated current A	Reference No	Unit MRP* ₹	Std. Pkg. (Nos.)
	Offset Tag	2	3NW TIA2	-	20
		4	3NW TIA4	-	
		6	3NW TIA6	-	
		10	3NW TIA10	-	
		16	3NW TIA16	-	
		20	3NW TIA20	-	
		25	3NW TIA25	-	
		32	3NW TIA32	-	
		40	3NW TIS40	-	
		50	3NW TIS50	-	
		63	3NW TIS63	-	

Available till stocks last

Betagard Distribution Boards 8GB31

	Item Description	Incoming Slots (MW)	Outgoing Slots (MW)	Total Slots (MW)	Reference No	Unit MRP* ₹	Std. Pkg.** (Nos.)
Betaflex (Flexi DBs), IP42 :							
	2Row x 12Mod	—	—	24	8GB31424RC	Price on request	1
	2Row x 16Mod	—	—	32	8GB31426RC		1
	4Row x 6Mod	—	—	24	8GB31441RC		1
	4Row x 8Mod	—	—	32	8GB31442RC		1
	4Row x 10Mod	—	—	40	8GB31443RC		1
	4Row x 12Mod	—	—	48	8GB31444RC		1
	4Row x 16Mod	—	—	64	8GB31446RC		1
Betabus (Vertical Busbar DBs with MCB as an incomer), IP42 : (Suitable for 5SL/5SP MCBs, upto 125A as an incomer)							
	4 way	12	12	24	8GB31471RC	Price on request	1
	6 way	12	18	30	8GB31473RC		1
	8 way	12	24	36	8GB31474RC		1
	12 way	12	36	48	8GB31477RC		1
Betabusplus (Vertical Busbar DBs with MCCB as an incomer), IP42 : (Suitable for 3VT1/3VA1 MCCBs, upto 160A as an incomer)							
	4 way	12	12	24	8GB31571RC	Price on request	1
	6 way	12	18	30	8GB31572RC		1
	8 way	12	24	36	8GB31573RC		1
	12 way	12	36	48	8GB31574RC		1
BetaMulti (DBs for power & communication), IP42 :							
	12 way SPN, provision	2	12	14	8GB31215RC	Price on request	1
	4 Way TPN, Provision	8	12	20	8GB31220RC		1
	6 way TPN, provision	8	18	26	8GB31221RC		1
	8 Way TPN Provision	8	24	32	8GB31222RC		1





Note:

* MRP - Maximum Retail Price

** Purchase MOQ for our authorized dealers is in multiples of standard packing, contact Siemens Sales Office for further details

Available till stocks last

Betagard Distribution Boards 8GB31

	Item Description	Incoming Slots (MW)	Outgoing Slots (MW)	Total Slots (MW)	Reference No	Unit MRP* ₹	Std. Pkg.** (Nos.)
Beta CO (DBs with built-in pre-wired phase changeover switches), IP42 :							
	40 A, 4 Way TPN, built-in	8	12	20	8GB31850RC	Price on request	1
	40 A, 6 Way TPN, built-in	8	18	26	8GB31851RC		1
	40 A, 8 Way TPN, built-in	8	24	32	8GB31852RC		1
	40 A, 12 Way TPN, built-in	8	36	44	8GB31854RC		1
	63 A, 4 Way TPN, built-in	8	12	20	8GB31860RC		1
	63 A, 6 Way TPN, built-in	8	18	26	8GB31861RC		1
	63 A, 8 Way TPN, built-in	8	24	32	8GB31862RC		1
	63 A, 12 Way TPN, built-in	8	36	44	8GB31864RC		1
Wire Way Boxes (WWB)							
	WWB for Flexi DB, 8Mod	—	—	—	8GB9908FWWNT	Price on request	1/5
	WWB for Flexi DB, 12Mod	—	—	—	8GB9912FWWNT		1/5
	WWB for Flexi DB, 16Mod	—	—	—	8GB9916FWWNT		1/5
	WWB for Bus DB	—	—	—	8GB99BUSWWNT		1/5
	WWB for Bus Plus DB	—	—	—	8GB99PLUSWWNT		1/5
Modular Device Boxes (MDB)							
	MDB for Flexi DB, 8Mod/Row	—	—	8	8GB9908FMDTC	Price on request	1/5
	MDB for Flexi DB, 12Mod/Row	—	—	12	8GB9912FMDTC		1/5
	MDB for Flexi DB, 16Mod/Row	—	—	16	8GB9916FMDTC		1/5
	MDB for Bus DB	—	—	12	8GB99BUSMBTC		1/5
	MDB for Bus Plus DB	—	—	12	8GB99PLUSMBTC		1/5
BetaMulti (DBs for power & communication), IP42 :							
	12 way SPN, built-in	2	12	14	8GB31315RC	Price on request	1
	4 Way TPN, Built-in	8	12	20	8GB31320RC		1
	6 way TPN, built-in	8	18	26	8GB31321RC		1
	8 Way TPN, Built-in	8	24	32	8GB31322RC		1
Beta CO (DBs with provision for phase changeover switches), IP42 :							
	4 way, with provision	8	12	20	8GB31840RC	Price on request	1
	6 way, with provision	8	18	26	8GB31841RC		1
	8 way, with provision	8	24	32	8GB31842RC		1
	12 way, with provision	8	36	44	8GB31844RC		1

Betagard Distribution Boards Accessories

	Item Description	Reference No	Unit MRP* ₹	Std. Pkg.** (Nos.)
Blanking Plate				
	1.5 MW	8GB9902	Price on request	25

Note:

* MRP - Maximum Retail Price

** Purchase MOQ for our authorized dealers is in multiples of standard packing, contact Siemens Sales Office for further details

Discontinued Products

Betagard Distribution Boards 8GB0

Reference No.	Reference No.	Reference No.	Reference No.
8GB0004	8GB0404HRC	8GB0412VRC	8GB0409VRC
8GB0006	8GB0406HRC	8GB0405HRC	8GB0413VRC
8GB0204RC	8GB0408HRC	8GB0407HRC	8GB0504
8GB0206RC	8GB0412HRC	8GB0409HRC	8GB0506
8GB0208RC	8GB0404VRC	8GB0413HRC	8GB0508
8GB0212RC	8GB0406VRC	8GB0405VRC	8GB0512
8GB0214RC	8GB0408VRC	8GB0407VRC	

Betagard Residual Current Circuit Breakers 5SM3

Reference No.	Reference No.	Reference No.	Reference No.
5SM33480RC	5SM36480RC	5SM33456RC	5SM36456RC
5SM33450RC	5SM36450RC	5SM34486RC	5SM37456RC
5SM34480RC	5SM37450RC	5SM34456RC	
5SM34450RC	5SM33486RC	5SM36486RC	

Auxiliary contact block for 5SM3 100-125A 4pole 1NO+1NC

Reference No.
5SW3330

Terms and Conditions

Maximum Retail Price (MRP) / List Price (LP) is subject to revision without prior notice.

The company reserves the right to supply goods at its works or godown at its discretion.

The minimum order size for non-stock items (items not marked with ■) is 50 Nos. for each item or ₹ 50,000/- per item.

Export control regulation - retention clause: The fulfillment of the agreement on Siemens part is subject to the provision that this shall not be prevented by implements on the grounds of national and international legal requirements, in particular export control provision.

Stock items

The normal stock items (indicated by ■) are subject to change without prior notice.

Note

- This supercedes all previous Price Lists.
- List Prices (LPs) mentioned are exclusive of all taxes.
- Maximum Retail Prices (MRPs) mentioned in the publication are maximum recommended selling prices.
- Invoice amount not to exceed MRP
- Invoice amount = MRP (less) applicable discount + applicable GST %
- For receiving material in factory sealed packing, we request you to order in multiples of the indicated standard packing quantity.

Ask your nearest Siemens partners to include you in our mailing list.

Always make your purchases only from our authorized dealers. Details available with our sales office/territory managers.



7KT PAC1200

Multichannel current measuring system for flexible multichannel monitoring in final distribution

Current Sensors

- Versions: 40 A, 63 A

Sensor Bar

- Versions available for 3, 6, 9, 12

Data Manager

- Connection of up to 96 sensors (40A/63A)
- DIN rail installation (4MW)

Communication/ Software:

- Modbus TCP/ IP
- Simple system onfiguration via web server
- Easy access to energy data with mobile app (iOS/Android)

*For more details, contact nearest Siemens Sales Office

siemens.com/powermonitoring

SIEMENS

- Modbus TCP/IP communication
- Simple configuration of system via powerconfig and web server
- Visualization of consumption via Webserver and Mobile App (Android/iOS)

- Flexible sensor bars and current sensors to record up to 96 circuits in one system
- Current sensors simply plug onto the sensor bars, eliminating extensive wiring

fast

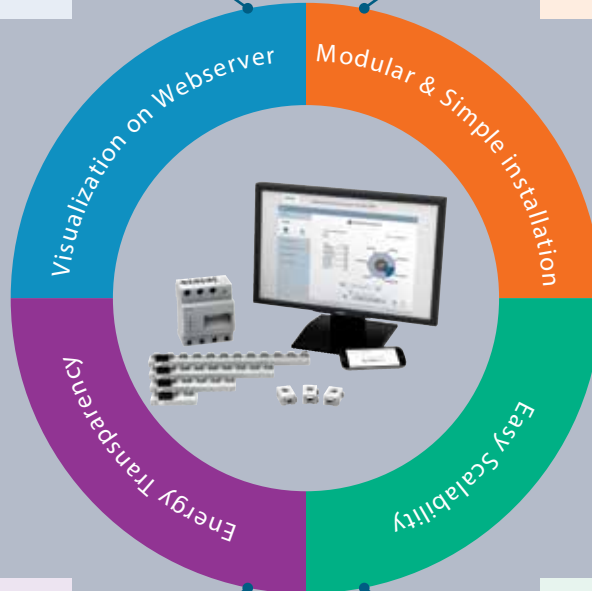

**plug
and
play**

- Targeted detection of power guzzlers
- Simultaneous display of power consumption and costs
- Ensures optimal power monitoring

- Easy to Upgrade
- Scale up the system without any interruption or cumbersome wiring



Easy



Transparent



Cost-efficient



Relevant Standards

Title	IS	IEC	Products							
			MCB		RCCB		RCBO	DB	AFDD	SPD
			5SL4/6/7	5SL5	5SV	5SM	5SU1	8GB	5SM6	5SD7
Electric Installations – MCBs for Building Installations and Similar Purposes Part 1: MCBs for AC Systems	IS 60898-1	IEC 60898-1	✓	–	–	–	–	–	–	–
Low-voltage switchgear and controlgear Part 2: Circuit-breakers	IS 60947-2	IEC 60947-2	–	✓	–	–	–	–	–	–
Residual Current Operated Circuit-Breakers for Household and Similar Uses, Part 1: Circuit-Breakers Without Integral Overcurrent Protection (RCCBs)	IS 12640-1	IEC 61008-1	–	–	✓	✓	–	–	–	–
Residual Current Operated Circuit-Breaking for Household and Similar Uses, Part 2: Circuit-Breakers with Integral Overcurrent Protection (RCBOs)	IS 12640-2	IEC 61009-1	–	–	–	–	✓	–	–	–
General requirements for arc fault detection devices	–	IEC 62606	–	–	–	–	–	✓	–	–
Low-voltage switchgear and controlgear assemblies, Part 2: Power switchgear and controlgear assemblies	–	IEC 61439-1/3	–	–	–	–	–	✓	–	–
Surge protective devices connected to low-voltage power systems	–	IEC 61643-11	–	–	–	–	–	–	–	✓



Degree of Protection

First digit: Protection against solid foreign objects		Second digit: Protection against ingress of water	
	0 No protection		0 No protection
	1 Protected against solid objects up to 50mm (e.g. hand)		1 Protection against vertically falling drops of water (e.g. condensation)
	2 Protected against solid objects up to 12mm diameter (e.g. finger)		2 Protection against direct sprays of water up to 15 degrees from vertical
	3 Protected against solid objects up to 2.5mm diameter (e.g. screwdriver)		3 Protection against direct sprays of water up to 60 degrees from vertical
	4 Protected against solid objects up to 1mm diameter (e.g. wire)		4 Protection against water sprayed from all directions, limited ingress permitted
	5 Protected against dust: limited ingress permitted, no harmful deposit.		5 Protected against low-pressure jets of water from all directions, limited ingress permitted
	6 Totally protected against dust		6 Protected against strong jets of water from all directions, limited ingress permitted (e.g. water from heavy seas on a ship's deck)
			7 Protected against the effect of temporary immersion (30 min) between 15cm and 1m
			8 Protected against long period of immersion under pressure
			9 Protected against high pressure, high temperature jets of water from multiple directions

Technical information



Installation Guideline for RCCB

RCCB suitability for various distribution networks.

Betagard RCCBs can be used in all 3 distribution network types viz. TN, TT & an IT network system. 4 pole RCCBs can also be used in 3 pole supply networks by adhering to installation guidelines. In this case, connection must be at terminals 1, 3 and 5 and 2, 4 and 6.

The function of the test equipment is only ensured if a jumper is fitted between terminals 3 and N.

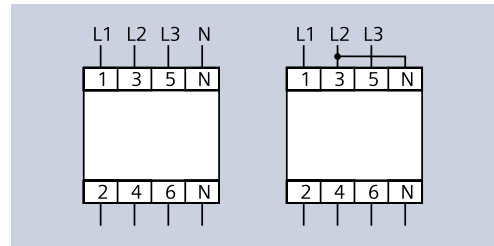

Types and waveform

					6 mA	10 mA		
Type AC		■	-	-	-	-	-	-
Type A		■	■	■	■	-	-	-
Type F		■	■	■	■	■	■	-
Type B		■	■	■	■	■	■	■
Type B+		■	■	■	■	■	■	■

Version

SIGRES	with active condensation protection for use in severe ambient conditions
[G] / [K]	super-resistant, 10 ms short-term delayed devices with increased immunity to false triggering due to transient disruptions
[S]	as an upstream group switch for selective shutdown against downstream RCCBs



Installation locations for Surge Protection Devices (SPDs)

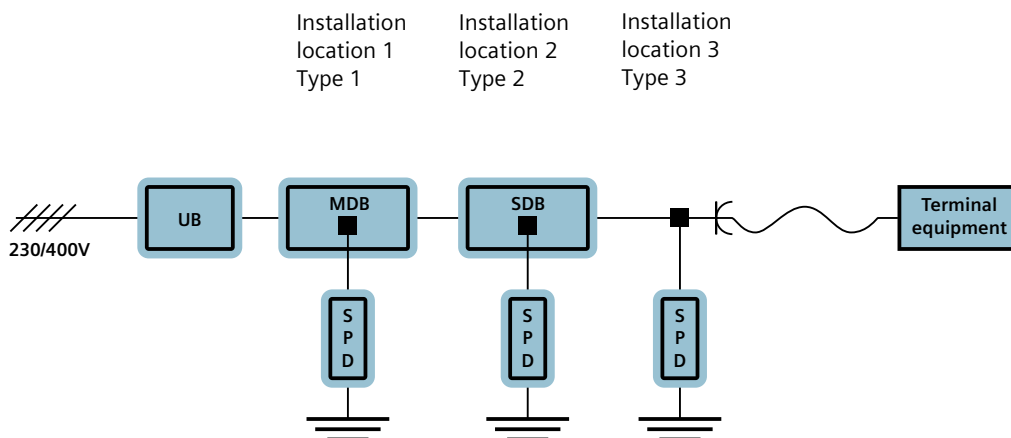

UB: Utility Box

MDB: Main distribution board

SDB: Sub Distribution board

Installation location 1 must be as close as possible to the supply point for the electrical system, so that the downstream installations are protected. The SPDs at installation locations 2 and 3 shall not be used without SPDs at installation location 1, and they must be coordinated with these SPDs (i.e. SPDs all from the same manufacturer).

One point contact for your service needs

The comprehensive range of services from Siemens is sure to cover the needs of the most varied users. We offer structured

services, designed to give you valuable support in every phase during the lifecycle of your Final Distribution Products.

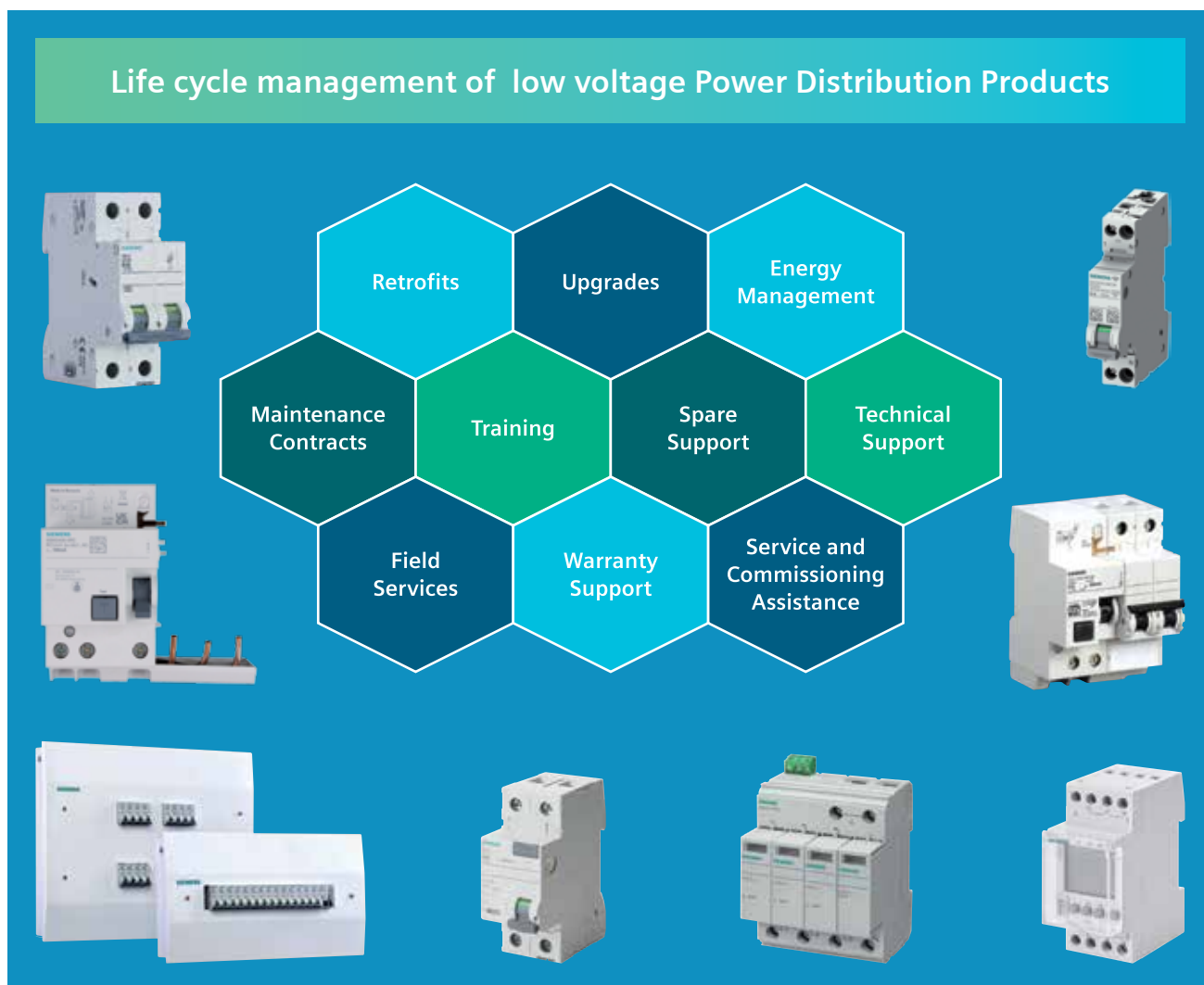

Please contact us for more details

CUSTOMER CARE

Toll Free No: 1800220987 / 18002090987 • E-mail: ics.india@siemens.com

Customer care

One stop support for all service needs:

- Breakdown service
- Annual maintenance contracts
- Retrofit solutions
- Spares
- Digitalization & Panel retrofits

For more details please contact:

Customer care desk

Siemens Limited

R&D Technology Centre

Thane Belapur Road, Airoli Node, Navi Mumbai - 400708

For more information contact toll free 1800 209 1800

Tel.: 022-27600150 • Fax: 022-33265381

<http://support.automation.siemens.com/in>

Notes

A series of horizontal dotted lines for taking notes.

Your partners

Sales offices:

Ahmedabad

3rd Floor, Prerna Arbour
Chimanlal Girdharlal Road, Navarangpura
Near Girish Colddrinks
Ahmedabad, Gujarat - 380009
Tel: +91 79 30927600
Fax: +91 79 30927699
Mobile: +91 9925001779
E-mail: chandrakant.keshrani@siemens.com

Baroda

Ground Floor, Urja Bhavan
Maneja Works, Opp. Makarpura Railway Station
Vadodara - 390010
Tel: +91 265 3957701
Fax: +91 265 3039190
Mobile: +91 9429037805
E-mail: kalpeshkumar.darji@siemens.com

Bengaluru

1st Floor, Jyoti Mahal, No. 49, St. Marks Rd.
Bengaluru - 560 001
Tel: +91 80 33422000
Fax: +91 80 33424131
Mobile: +91 9880003710
E-mail: gauri.menoky@siemens.com

Bhubaneswar

Mobile: +91 8696222212
E-mail: rohit.nandan@siemens.com

Chandigarh

Mobile: +91 9888484066
E-mail: padam.sharma@siemens.com

Chennai

"Srivari Srimath", 3rd Floor, Room-312
Door No.1045, Avinashi Road
Coimbatore - 641018, Tamil Nadu
Mobile: +91 9176609375
E-mail: muthu.kumar@siemens.com

Coimbatore

Mobile: +91 9894617776
E-mail: sivaprakasam.r@siemens.com

Gurgaon

DLF Cyber Park, Tower B, 10th Floor
Udyog Vihar, Phase III, Sector 20
Gurugram - 122008
Tel: +91 124 2842000, 3810200
Mobile: +91 9971091588
E-mail: manjeet.mor@siemens.com

Hyderabad

5-9-19, Lakshmi Narasinh Estate
Hyderabad - 500004
Tel.: +91 40 23482578
Mobile: +91 9949047350
E-mail: ms.murugaraj@siemens.com

Jaipur

Mobile: +91 9818099433
E-mail: rajesh.raina@siemens.com

Jamshedpur

Mobile: +91 8294052647
E-mail: shyamal.bhattacharyya@siemens.com

Kolkata

3rd Floor, 43, Shanti Palli
Rashbihari Bypass Connector
Kolkata - 700042, India
Tel: +91 33 30939000
Fax: +91 33 30939010
Mobile: +91 9051015666
E-mail: amarnath.karmakar@siemens.com

Lucknow

Mobile: +91 9918002525
E-mail: atul.shukla@siemens.com

Mumbai

Business Centre-1, Kalwa Works
Thane Belapur Road
Thane - 400 601
Tel : +91 22 39663000
Fax: +91 22 39663721
Mobile: +91 9822467311
E-mail: abhijeet.dandekar@siemens.com

Nagpur

Mobile: +91 9049610003
E-mail: sanjay.lonkar@siemens.com

Pune

Tower C, Panchshil Business Park
Survey No. 20, Balewadi
Pune - 411045
Tel: +91 20 30466000
Fax: +91 20 30466060
Mobile: +91 9167934328
E-mail: kiran.kanhurkar@siemens.com

Territory managers:

Belgaum

Mobile: +91 8105592066
E-mail: siddu.mareguddi@siemens.com

Bharuch

Mobile: +91 8884000998
E-mail: viral.kachhadia@siemens.com

Bhopal

Mobile: +91 9926415756
E-mail: laxmi-narayan.dhakar@siemens.com

Cochin

Mobile: +91 9447313241
E-mail: max.tom@siemens.com

Guwahati

Mobile: +91 9864110684
E-mail: biplab.datta@siemens.com

Haridwar

Mobile: +91 9808380848
E-mail: rahul.kothari@siemens.com

Indore

Mobile: +91 8600555694
E-mail: paresh.bhachawat@siemens.com

Jalandhar

Mobile: +91 9876047929
E-mail: sunil.singla@siemens.com

Jodhpur

Mobile: +91 8003088889
E-mail: ankur.pancholi@siemens.com

Kolhapur

Mobile: +91 9112633253
E-mail: vijaykumar.patil@siemens.com

Kota

Mobile: +91 9929110493
E-mail: rajendra.kabra@siemens.com

Ludhiana

Mobile: +91 9872419990
E-mail: ravinder.pal@siemens.com

Nagpur

Mobile: +91 9049610003
E-mail: sanjay.lonkar@siemens.com

Nashik

Mobile: +91 9833256139
E-mail: mayur.kulkarni@siemens.com

Raipur

Mobile: +91 9926511479
E-mail: ravindra.ughade@siemens.com

Rajkot

Mobile: +91 9033146951
E-mail: shivang.bhatt@siemens.com

Ranchi

Mobile: +91 7033537344
E-mail: soumitra.dutta@siemens.com

Rourkela

Mobile: +91 9861056581
E-mail: ashirbad.das@siemens.com

Rudrapur

Mobile: +91 9839174578
E-mail: girish.pandey@siemens.com

Sonepat

Mobile: +91 9911316981
E-mail: mohit.bisaria@siemens.com

Sricity

Mobile: +91 8122072921
E-mail: m.karthikeyan@siemens.com

Sriperumbadur

Mobile: +91 7506283408
E-mail: senthil-kumaran.chetty@siemens.com

Surat

Mobile: +91 9879110276
E-mail: rahul.gangrade@siemens.com

Trichy

Mobile: +91 9840255185
E-mail: r.pradeep@siemens.com

Vapi

Mobile: +91 9867021215
E-mail: akif.qadeer@siemens.com
Mobile: +91 9820073112
E-mail: deepak.doke@siemens.com

Varanasi

Mobile: +91 9984500021
E-mail: kumardeepak@siemens.com

Vizag

Mobile: +91 9618046037
E-mail: sivadurgaprasad.mondeti@siemens.com

Siemens Limited
Smart Infrastructure
Electrical Products
R&D Technology Centre
Thane Belapur Road
Airoli Node, Navi Mumbai - 400708
For more information contact toll free 1800 209 1800
E-mail: lvsg-r-mktg.india@siemens.com

Order No.: 115086190
SI-EP-CC-DIPL-102024
(This replaces SI-EP-CC-DIPL-102023
dated 15 October, 2023)

Customer Care Toll free no. 1800 209 0987
Email: ics.india@siemens.com

Product upgradation is a continuous process. Hence, data in this pricelist is subject to change without prior notice. For the latest information, please get in touch with our Sales Offices.